

*** ZUSATZKATALOG 2021 ***

MB Handel GmbH

Raiffeisenstr. 13

D-71126 Gäufelden

Tel +49 (0)7032 / 91 04 36-0

Fax +49 (0)7032 / 91 04 36-4

E-Mail info@mb-handel-gmbh.de

Web www.mb-handel-gmbh.de



OFFICE FURNITURE

FEATURES

- » Durable Welded Metal Construction
- » Electrostatic Powder Coating
- » Wall Mounting Holes on Rear Top
- » Adjustable Shelves with A4 Suspension File Support
- » Reinforced Doors with Concealed Hinges and Anti-Noise Plastic Buffers
- » 2.000 Differs 2 Point Flush Handle Lock with 2 Keys
- » Key Duplicate Support
- » Masterkey Support
- » Packaging: Nylon Bag + Corrugated Carton

OPTIONAL

- » Inner & Top Cupboards
- » Goose Neck Doors
- » Swan Neck Doors
- » Wheel Combination Lock
- » 1.000 Differs 3 Point Flush Handle Lock with 2 Keys
- » Same Lock Number
- » Effective Transport for Sets with Two or Three Cupboards in One Package

STANDARD COLORS FOR THIS RANGE



- » Non-standard colors are available with price difference (extra charge)
- » Production codes are referring items completely in color Grey 7035

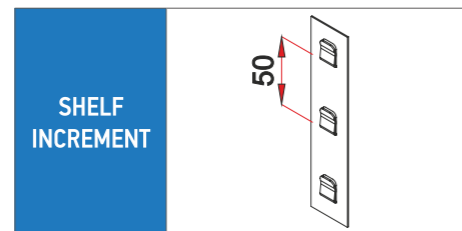
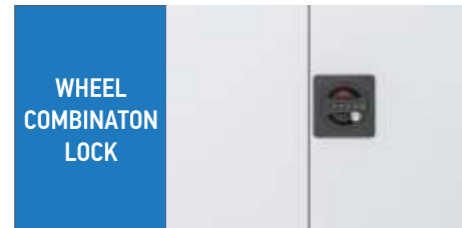

Monoblock

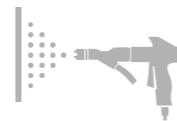

Powder Coated



Key Lock



Suspension File



Cleaning



Warranty



view									
catalogue code	FLC.07	FLC.10	FLC.101	FLC.12	FLC.122	FLC.18	FLC.181	FLC.19	FLC.192
production code	152M0101-00001	152M0101-00002	152M0101-00003	152M0101-00004	152M0101-00005	152M0101-00006	152M0101-00007	152M0101-00008	152M0101-00009
no of shelf	1	2	2	2	2	4	4	4	4
height (mm)	750	1000	1000	1200	1200	1800	1800	1950	1950
width (mm)	800	800	1000	925	1200	800	1000	925	1200
depth (mm)	383	383	383	422	422	383	383	422	422

view		
catalogue code	TC/FLC.459242	TC/FLC.451242
production code	152M9901-00001	152M9901-00002
item	top cupboard	top cupboard
height (mm)	450	450
width (mm)	925	1200
depth (mm)	422	422

view		
catalogue code	IC/FLC.409242	IC/FLC.401242
production code	152M9901-00003	152M9901-00004
item	inner cupboard	inner cupboard
height (mm)	400	400
width (mm)	835	1110
depth (mm)	350	350

view	
catalogue code	SDBH-0002
production code	152M9901-00005
item	shelf divider / book holder

FEATURES

- » Durable Welded Metal Construction
- » Electrostatic Powder Coating
- » Wall Mounting Holes on Rear Top
- » Adjustable Shelves with A4 Suspension File Support
- » Roll-Out Suspension File Frame and Shelf
- » Roll-Out Drawer for Various Usage
- » Smooth Rolling Plastic Doors with Magnetic Metal Locking Slat
- » Levelling Feet
- » Desk End Use in 750 mm High Models
- » 1.000 Differs Lock with Double Hook and 2 Keys
- » Key Duplicate Support
- » Masterkey Support
- » Packaging: Nylon Bag + Corrugated Carton

OPTIONAL

- » Wooden Top
- » Inner & Top Cupboards
- » Wheel Combination Lock
- » Same Lock Number
- » Effective Transport for Sets with Two Cupboards in One Package

STANDARD METAL COLORS FOR THIS RANGE



STANDARD SHUTTER COLORS FOR THIS RANGE

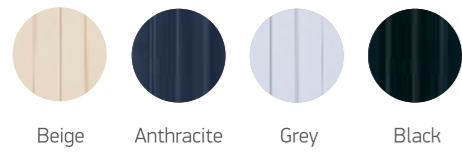

- » Non-standard colors are available with price difference (extra charge)
- » Production codes are referring items completely in color Grey 7035

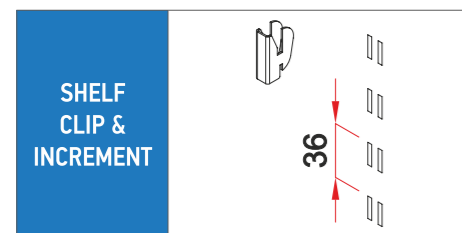

Monoblock

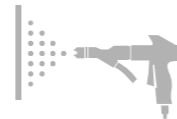

Powder Coated



Key Lock



Suspension File



Cleaning



Warranty



800 mm WIDE SERIES				
view				
catalogue code	SDC.0708	SDC.1008	SDC.1308	SDC.1908
production code	152M0102-00001	152M0102-00002	152M0102-00003	152M0102-00004
no of shelf	1	2	2	4
height (mm)	750	1050	1350	1950
width (mm)	800	800	800	800
depth (mm)	457	457	457	457

1000 mm WIDE SERIES				
view				
catalogue code	SDC.0710	SDC.1010	SDC.1310	SDC.1910
production code	152M0102-00005	152M0102-00006	152M0102-00007	152M0102-00008
no of shelf	1	2	2	4
height (mm)	750	1050	1350	1950
width (mm)	1000	1000	1000	1000
depth (mm)	457	457	457	457

1200 mm WIDE SERIES				
view				
catalogue code	SDC.0712	SDC.1012	SDC.1312	SDC.1912
production code	152M0102-00009	152M0102-00010	152M0102-00011	152M0102-00012
no of shelf	1	2	2	4
height (mm)	750	1050	1350	1950
width (mm)	1200	1200	1200	1200
depth (mm)	457	457	457	457

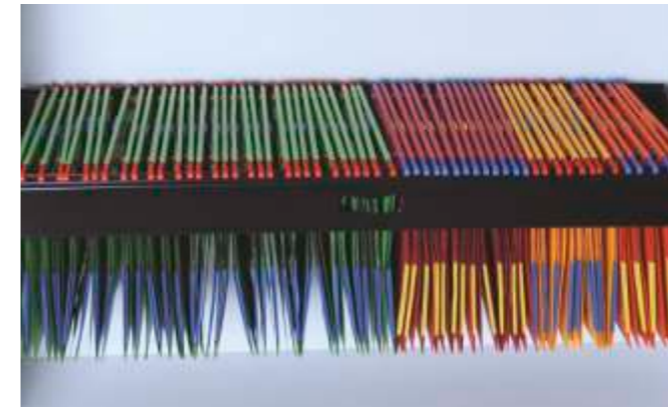

TOP CUPBOARDS			
view			
catalogue code	TC/SDC.458046	TC/SDC.451046	TC/SDC.451246
production code	152M9902-00001	152M9902-00002	152M9902-00003
height (mm)	450	450	450
width (mm)	800	1000	1200
depth (mm)	457	457	457

INNER CUPBOARDS		
view		
catalogue code	IC/SDC.401046	IC/SDC.401246
production code	152M9902-00004	152M9902-00005
for cabinets	1000(w)*457(d)	1200(w)*457(d)
height (mm)	400	400
width (mm)	800	1000
depth (mm)	350	350



ROLL-OUT ACCESSORIES						
view						
catalogue code	TLF/SDC.1046	TLF/SDC.1246	TLD/SDC.1046	TLD/SDC.1246	TLS/SDC.1046	TLS/SDC.1246
production code	152M9902-00006	152M9902-00007	152M9902-00008	152M9902-00009	152M9902-00010	152M9902-00011
item	telescopic frame		telescopic drawer		telescopic shelf	
for cabinets	1000(w)*450-457(d)	1200(w)*450-457(d)	1000(w)*450-457(d)	1200(w)*450-457(d)	1000(w)*450-457(d)	1200(w)*450-457(d)

STATIONARY ACCESSORIES				
view				
catalogue code	SFF/SDC.1046	SFF/SDC.1246	LTS/SDC.1046	LTS/SDC.1246
production code	152M9902-00012	152M9902-00013	152M9902-00014	152M9902-00015
item	stationary frame		letter sorter	
for cabinets	1000(w)*450-457(d)	1200(w)*450-457(d)	1000(w)*450-457(d)	1200(w)*450-457(d)

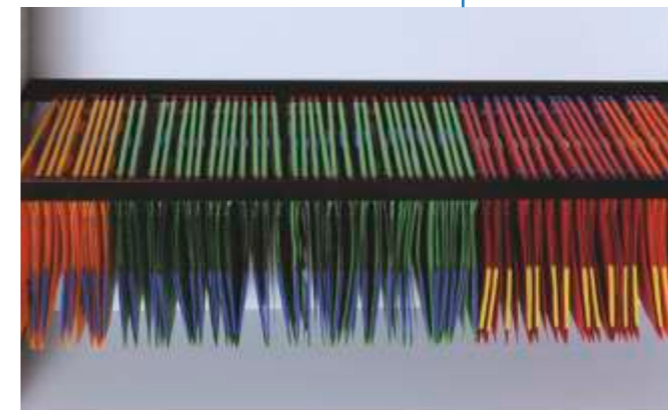
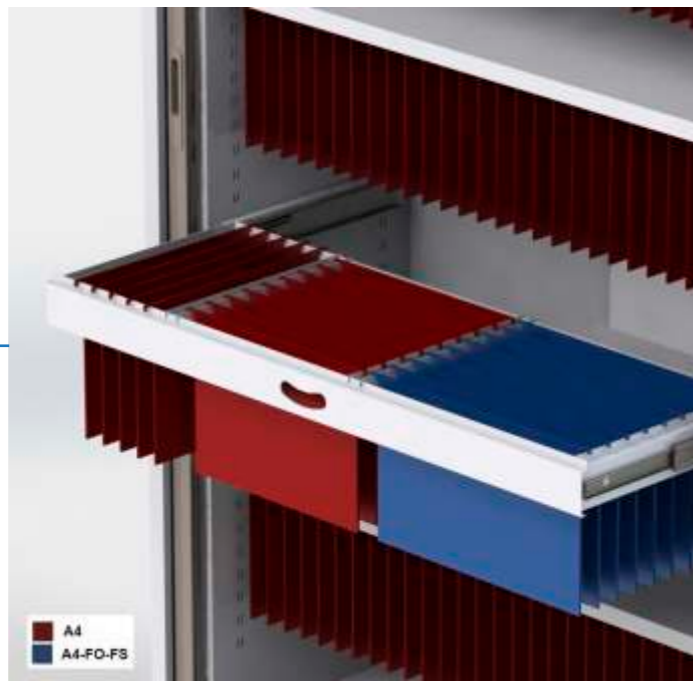
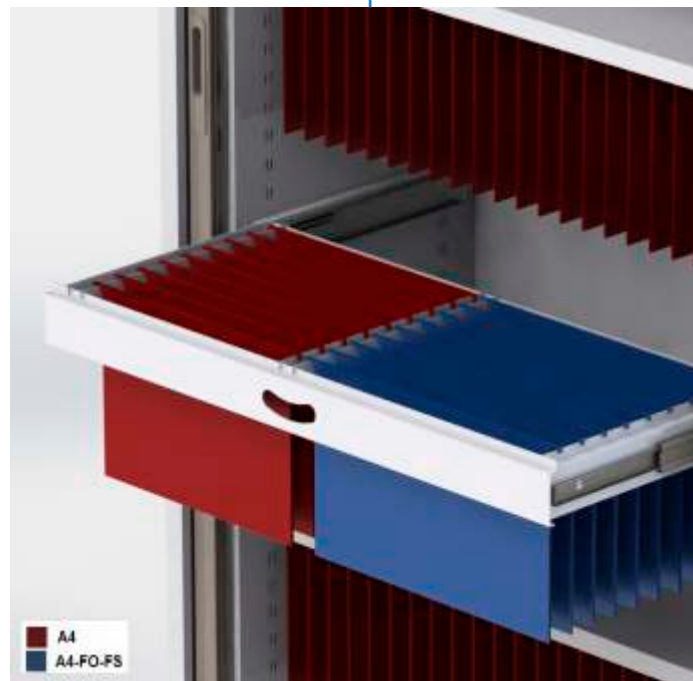

SHELF DIVIDER / BOOK HOLDER	
view	
catalogue code	SDBH-0003
production code	152M9902-00016



FEATURES

- » Durable Welded Metal Construction
- » Electrostatic Powder Coating
- » Wall Mounting Holes on Rear Top
- » Adjustable Shelves with A4 Suspension File Support
- » Silent and Reinforced Sliding Metal Doors on Rollers
- » Central Partition on 1600 mm Wide Models
- » Desk End Use in 750 mm High Models
- » Levelling Feet
- » 1.000 Differs Push Lock with 2 Keys
- » Key Duplicate Support
- » Masterkey Support
- » Packaging: Nylon Bag + Corrugated Carton

OPTIONAL

- » Wooden Top
- » Top Cupboards
- » Wheel Combination Lock

STANDARD COLORS FOR THIS RANGE



- » Non-standard colors are available with price difference (extra charge)
- » Production codes are referring items completely in color Grey 7035



Monoblock



Powder Coated



Key Lock



Suspension File



Cleaning



Warranty



view						
catalogue code	SLC.0708	SLC.0712	SLC.0716	SLC.1012	SLC.1016	SLC.1912
production code	152M0103-00001	152M0103-00002	152M0103-00003	152M0103-00004	152M0103-00005	152M0103-00006
no of shelf	1	1	2 [1+1]	2	4 [2+2]	4
height (mm)	750	750	750	1090	1090	1950
width (mm)	800	1200	1600	1200	1600	1200
depth (mm)	450	450	450	450	450	450

TOP CUPBOARD	
view	
catalogue code	TC/SLC.451245
production code	152M9903-00001
height (mm)	450
width (mm)	1200
depth (mm)	450

SHELF DIVIDER / BOOK HOLDER	
view	
catalogue code	SDBH-0002
production code	152M9901-00005

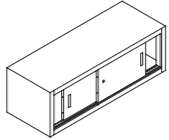
TOP CUPBOARDS	
view	
catalogue code	TC/SLC.451245
production code	152M9903-00001
height (mm)	450
width (mm)	1200
depth (mm)	450

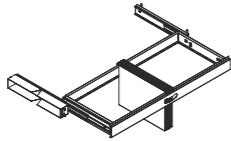
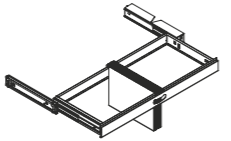
ROLL OUT ACCESSORIES / TELESCOPIC FILING FRAME			
view			
catalogue code	TLF/SLC/FP.1445	TLF/SLC/FP.1645	TLF/SLC/FP.1845
production code	152M9903-00002	152M9903-00003	152M9903-00004
for cabinets	1400(w)*450(d)	1600(w)*450(d)	1800(w)*450(d)

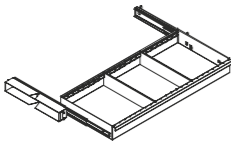
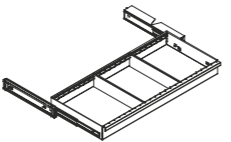
ROLL OUT ACCESSORIES / TELESCOPIC DRAWER			
view			
catalogue code	TLD/SLC/FP.1445	TLD/SLC/FP.1645	TLD/SLC/FP.1845
production code	152M9903-00005	152M9903-00006	152M9903-00007
for cabinets	1400(w)*450(d)	1600(w)*450(d)	1800(w)*450(d)

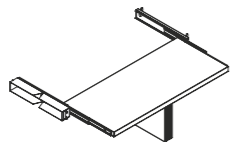
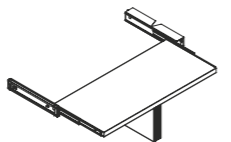
ROLL OUT ACCESSORIES / TELESCOPIC SHELF			
view			
catalogue code	TLS/SLC/FP.1445	TLS/SLC/FP.1645	TLS/SLC/FP.1845
production code	152M9903-00008	152M9903-00009	152M9903-00010
for cabinets	1400(w)*450(d)	1600(w)*450(d)	1800(w)*450(d)



FEATURES

- » Durable Metal Construction
- » Electrostatic Powder Coating
- » 4-legged
- » Individual Turning 18 mm Wooden Racks
- » 2 mm Edgebanding Prevents Folders Falling Down
- » 24 Folder Capacity on Each Rack
- » Folder Separation Wires and Turning-Handles on Each Rack
- » Easy Assembly
- » Packaging: Flatpack in Corrugated Carton

STANDARD METAL COLORS FOR THIS RANGE



7035
Grey

STANDARD MELAMINE COLORS FOR THIS RANGE

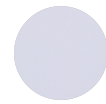

Grey

- » Non-standard colors are available with price difference (extra charge)
- » Production codes are referring items completely in color Grey 7035



Flatpack

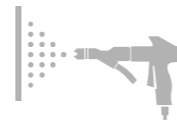

Powder Coated



Cleaning



Warranty



view					
catalogue code	TFR.2	TFR.3	TFR.4	TFR.5	TFR.6
production code	152M0106-00001	152M0106-00002	152M0106-00003	152M0106-00004	152M0106-00005
folder height	2	3	4	5	6
shelf Ø	805	805	805	805	805
height (mm)	840	1207	1575	1943	2311
distance between shelves (mm)	350	350	350	350	350

view		
catalogue code	SPR/TFR	CS/TFR
production code	152M9916-00001	152M9916-00002
item	separator	castor set
size	200*358*285	100(H)*Ø75
remark		applicable till TFR.4 (max)

FEATURES

- » Durable Welded Metal Construction
- » Electrostatic Powder Coating
- » Use for Papers A0 and A1 Sizes
- » Drawers on Telescopic Slides
- » Flush Drawers with 2 Handles
- » Stamped Label Holder on Each Drawer
- » Each Drawer with Flap Rod Paper Clamp in Front & Rear Hood
- » Stackable - Up to Three Cabinets
- » Central Locking System
- » 2.000 Differs Square Head Pedestal Lock with 2 Keys
- » Key Duplicate Support
- » Masterkey Support
- » Packaging: Strech Wrapped & Delivery on Pallet

STANDARD METAL COLORS FOR THIS RANGE



STANDARD MELAMINE COLORS FOR THIS RANGE



- » Non-standard colors are available with price difference (extra charge)
- » Production codes are referring items completely in color Grey 7035



flap rod paper clamp



WHEEL COMBINATON LOCK

OPTIONAL

- » Plastic Divider for Various Paper Sizes
- » 150 mm Base
- » 150 mm Framed Feet
- » 165 mm Castor
- » Wheel Combination Lock



Monoblock

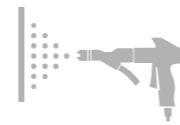

Powder Coated



Key Lock

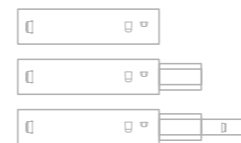

Telescopic Drawer Slide



Cleaning



Warranty



FLUSH DRAWERS				
view				
catalogue code	MPC/FD.5.A0	MPC/FD.5.A1	MPC/FD.6.A0	MPC/FD.6.A1
production code	152M0107-00001	152M0107-00002	152M0107-00003	152M0107-00004
no of drawers	5	5	6	6
height (mm)	535	535	615	615
width (mm)	1400	1130	1400	1130
depth (mm)	950	830	950	830

various paper size usage option

item A0 Cabinet

various paper size usage option

item A1 Cabinet

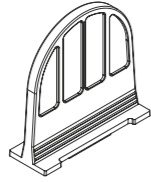
DIVIDER	
view	
catalogue code	PRT/MPC
production code	152M9904-00001
for items	A0 & A1
height (mm)	50
length (mm)	50

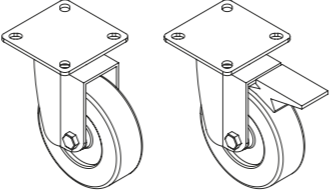
castor	
code	CS/MPC
remark	* can not be fixed afterwards * should be ordered together with the product

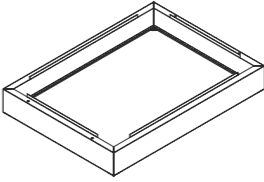
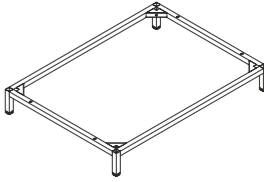
ACCESSORIES				
view				
catalogue code	BS.A0	BS.A1	FRF.A0	FRF.A1
production code	152M9904-00002	152M9904-00003	152M9904-00004	152M9904-00005
item	base		framed feet	
for items	A0	A1	A0	A1
height (mm)	150	150	150	150
width (mm)	1400	1130	1400	1130
depth (mm)	950	830	950	830



FEATURES

- » Durable Welded Metal Construction
- » Electrostatic Powder Coating
- » Use for Papers A0 and A1 Sizes
- » Drawers on Telescopic Slides
- » Full Size Gooseneck Handle
- » Stamped Label Holder on Each Drawer
- » Each Drawer with Flap Rod Paper Clamp in Front & Rear Hood
- » Stackable - Up to Three Cabinets
- » Central Locking System
- » 2.000 Differs Square Head Pedestal Lock with 2 Keys
- » Key Duplicate Support
- » Masterkey Support
- » Packaging: Strech Wrapped & Delivery on Pallet

STANDARD METAL COLORS FOR THIS RANGE



STANDARD MELAMINE COLORS FOR THIS RANGE



- » Non-standard colors are available with price difference (extra charge)
- » Production codes are referring items completely in color Grey 7035



flap rod paper clamp



WHEEL COMBINATON LOCK

OPTIONAL

- » Plastic Divider for Various Paper Sizes
- » 1500 mm Base
- » 1500 mm Framed Feet
- » 1650 mm Castor
- » Wheel Combination Lock



Monoblock

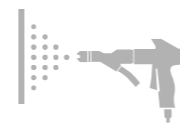

Powder Coated



Key Lock

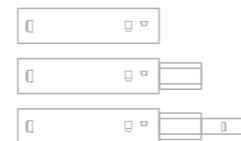

Telescopic Drawer Slide



Cleaning



Warranty



view				
catalogue code	MPC/5.A0	MPC/5.A1	MPC/6.A0	MPC/6.A1
production code	152M0107-00005	152M0107-00006	152M0107-00007	152M0107-00008
no of drawers	5	5	6	6
height (mm)	535	535	615	615
width (mm)	1400	1130	1400	1130
depth (mm)	950	830	950	830

various paper size usage option	
item	A0 Cabinet

various paper size usage option	
item	A1 Cabinet

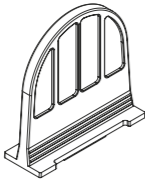
DIVIDER	
view	
catalogue code	PRT/MPC
production code	152M9904-00001
for items	A0 & A1
height (mm)	50
length (mm)	50

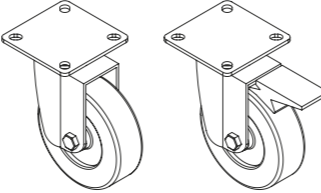
castor	
code	CS/MPC
remark	* can not be fixed afterwards * should be ordered together with the product

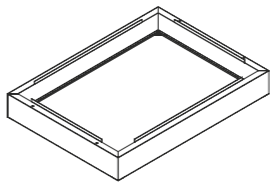
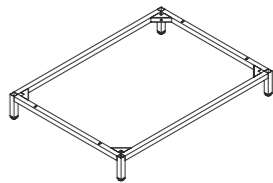
ACCESSORIES				
view				
catalogue code	BS.A0	BS.A1	FRF.A0	FRF.A1
production code	152M9904-00002	152M9904-00003	152M9904-00004	152M9904-00005
item	base		framed feet	
for items	A0	A1	A0	A1
height (mm)	150	150	150	150
width (mm)	1400	1130	1400	1130
depth (mm)	950	830	950	830



FEATURES

- » Durable Welded Metal Construction
- » Electrostatic Powder Coating
- » Drawers on Telescopic Slides
- » Full Size Gooseneck Handle
- » Central Locking System
- » 2.000 Differs Square Head Pedestal Lock with 2 Keys
- » Key Duplicate Support
- » Masterkey Support
- » Packaging: Nylon Bag + Corrugated Carton

OPTIONAL

- » Wheel Combination Lock

STANDARD COLORS FOR THIS RANGE



- » Non-standard colors are available with price difference (extra charge)
- » Production codes are referring items completely in color Grey 7035



view		
catalogue code	MDC/A3.8	MDC/A3.13
production code	152M0108-00001	152M0108-00002
no of drawers	8	13
height (mm)	980	980
width (mm)	530	530
depth (mm)	430	430

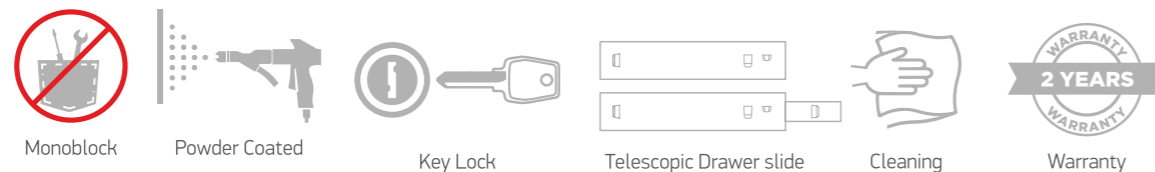

FEATURES

- » Durable Welded Metal Construction
- » Electrostatic Powder Coating
- » Drawers on Full Extension Runner Tracks
- » Chrome Plated Bow Handle
- » Stamped Label Holder
- » No Locking
- » Packaging: Nylon Bag + Corrugated Carton

STANDARD COLORS FOR THIS RANGE

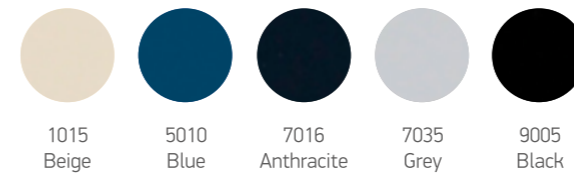

- » Non-standard colors are available with price difference (extra charge)
- » Production codes are referring items completely in color Grey 7035



view							
catalogue code	MDC/A4.5	MDC/A4.6	MDC/A4.9	MDC/A4.10	MDC/A4.12	MDC/A4.15	MDC/A4.18
production code	152M0108-00003	152M0108-00004	152M0108-00005	152M0108-00006	152M0108-00007	152M0108-00008	152M0108-00009
no of drawers	5	6	9	10	12	15	18
height (mm)	325	375	595	645	745	895	1045
width (mm)	300	300	300	300	300	300	300
depth (mm)	400	400	400	400	400	400	400



FEATURES

- » Durable Welded Metal Construction
- » Electrostatic Powder Coating
- » Drawers on Full-Extension Telescopic Slides
- » Drawers with Advanced Anti-Tilt Mechanism
- » Full Size Gooseneck Handle
- » Adhesive Label Holders
- » Adjustable Suspension File Bar
- » Central Locking System
- » 2.000 Differs Square Head Pedestal Lock with 2 Keys
- » Key Duplicate Support
- » Masterkey Support
- » Packaging: Nylon Bag + Corrugated Carton

OPTIONAL

- » Wooden Front Drawers
- » Wheel Combination Lock



Monoblock



Powder Coated



Key Lock



Telescopic Drawer Slide

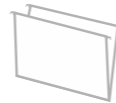

Suspension File



Drawer Anti-Tilt System



Cleaning



Warranty



STANDARD COLORS FOR THIS RANGE



STANDARD MELAMINE COLORS FOR THIS RANGE



- » Non-standard colors are available with price difference (extra charge)
- » Production codes are referring items completely in color Grey 7035

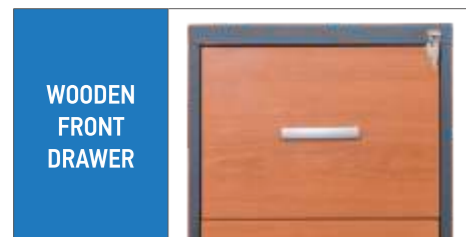

WOODEN FRONT DRAWER



WHEEL COMBINATOR LOCK



LETTER



A4



A4

FOOLSCAP



400 mm WIDE SERIES

view			
catalogue code	FGC.2.(40)	FGC.3.(40)	FGC.4.(40)
production code	152M0109-00001	152M0109-00002	152M0109-00003
no of drawers	2	3	4
height (mm)	705	1012	1320
width (mm)	400	400	400
depth (mm)	620	620	620
suspension file size	LETTER+A4	LETTER+A4	LETTER+A4

435 mm WIDE SERIES

view			
catalogue code	FGC.2.(43)	FGC.3.(43)	FGC.4.(43)
production code	152M0109-00004	152M0109-00005	152M0109-00006
no of drawers	2	3	4
height (mm)	705	1012	1320
width (mm)	435	435	435
depth (mm)	620	620	620
suspension file size	LETTER+A4+FOLIO	LETTER+A4+FOLIO	LETTER+A4+FOLIO

460 mm WIDE SERIES

view			
catalogue code	FGC.2.(46)	FGC.3.(46)	FGC.4.(46)
production code	152M0109-00007	152M0109-00008	152M0109-00009
no of drawers	2	3	4
height (mm)	705	1012	1320
width (mm)	460	460	460
depth (mm)	620	620	620
suspension file size	LETTER+A4+FOLIO+FS	LETTER+A4+FOLIO+FS	LETTER+A4+FOLIO+FS

FEATURES

- » Durable Welded Metal Construction
- » Electrostatic Powder Coating
- » Drawers on Full-Extension Telescopic Slides
- » Drawers with Advanced Anti-Tilt Mechanism
- » Full Size Gooseneck Handle
- » Adhesive Label Holders
- » Adjustable Suspension File Bar
- » Central Locking System
- » 2.000 Differs Square Head Pedestal Lock with 2 Keys
- » Key Duplicate Support
- » Masterkey Support
- » Packaging: Nylon Bag + Corrugated Carton

OPTIONAL

- » Wooden Front Drawers
- » Wheel Combination Lock



Monoblock



Powder Coated



Key Lock

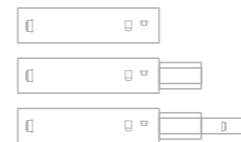

Telescopic Drawer Slide



Suspension File



Drawer Anti-Tilt System



Cleaning



Warranty

STANDARD COLORS FOR THIS RANGE



STANDARD MELAMINE COLORS FOR THIS RANGE



- » Non-standard colors are available with price difference (extra charge)
- » Production codes are referring items completely in color Grey 7035



WOODEN FRONT DRAWER



WHEEL COMBINATOR LOCK



760 mm WIDE SERIES

view			
catalogue code	FGC/D.2.(76)	FGC/D.3.(76)	FGC/D.4.(76)
production code	152M0109-00010	152M0109-00011	152M0109-00012
no of drawers	2	3	4
height (mm)	705	1012	1320
width (mm)	760	760	760
depth (mm)	620	620	620
suspension file size	LETTER+A4	LETTER+A4	LETTER+A4

820 mm WIDE SERIES

view			
catalogue code	FGC/D.2.(82)	FGC/D.3.(82)	FGC/D.4.(82)
production code	152M0109-00013	152M0109-00014	152M0109-00015
no of drawers	2	3	4
height (mm)	705	1012	1320
width (mm)	820	820	820
depth (mm)	620	620	620
suspension file size	LETTER+A4+FOLIO	LETTER+A4+FOLIO	LETTER+A4+FOLIO

870 mm WIDE SERIES

view			
catalogue code	FGC/D.2.(87)	FGC/D.3.(87)	FGC/D.4.(87)
production code	152M0109-00016	152M0109-00017	152M0109-00018
no of drawers	2	3	4
height (mm)	705	1012	1320
width (mm)	870	870	870
depth (mm)	620	620	620
suspension file size	LETTER+A4+FOLIO+FS	LETTER+A4+FOLIO+FS	LETTER+A4+FOLIO+FS

DESKTOP CARD & INDEX CABINETS

FEATURES

- » Durable Welded Metal Construction
- » Electrostatic Powder Coating
- » Metal Supports in Drawers
- » Drawers on Full Extension Runner Tracks
- » Packaging: Nylon Bag + Corrugated Carton

OPTIONAL

- » Lock with 2 Keys



STANDING CARD & INDEX CABINETS

FEATURES

- » Durable Welded Metal Construction
- » Electrostatic Powder Coating
- » Metal Supports in Drawers
- » Drawers on Full-Extension Telescopic Slides
- » Drawers with Advanced Anti-Tilt Mechanism
- » Full Size Gooseneck Handle
- » Adhesive Label Holders
- » Central Locking System
- » 2.000 Differs Square Head Pedestal Lock with 2 Keys
- » Key Duplicate Support
- » Masterkey Support
- » Packaging: Nylon Bag + Corrugated Carton

OPTIONAL

- » Wheel Combination Lock



Monoblock



Powder Coated



Key Lock



Telescopic Drawer Slide



Drawer Anti-Tilt System



Cleaning



Warranty

STANDARD COLORS FOR THIS RANGE

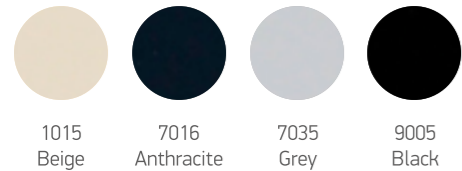

- » Non-standard colors are available with price difference (extra charge)
- » Production codes are referring items completely in color Grey 7035

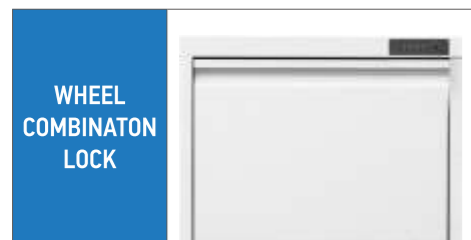

WHEEL COMBINATOR LOCK



DESKTOP MODEL	
view	
catalogue code	DCIC.1.A5
production code	152M0110-00001
card size	A5
height (mm)	205
width (mm)	270
depth (mm)	400



STANDING MODEL		
view		
catalogue code	CIC.6(2).A5	CIC.6(3).A5
production code	152M0110-00002	152M0110-00003
no of drawer	6	6
row / drawer	2	3
divider / per drawer	2	3
card size	A5	A5
height (mm)	1320	1320
width (mm)	530	760
depth (mm)	620	620

FEATURES

- » Durable Welded Metal Construction
- » Electrostatic Powder Coating
- » Wall Mount Hole on Back Top
- » Can be Bolted Side by Side
- » 115 Degree Flap Doors
- » Stamped Label Holder on Doors
- » Anti-Noise Plastic Buffers on Doors
- » Doors with Magnetic Catch & Locked Models
- » Locked Models with 2.000 Differs Round Head Camlock with 2 Keys
- » Key Duplicate Support
- » Masterkey Support
- » Packaging: Nylon Bag + Corrugated Carton

STANDARD COLORS FOR THIS RANGE



- » Non-standard colors are available with price difference (extra charge)
- » Production codes are referring items completely in color Grey 7035

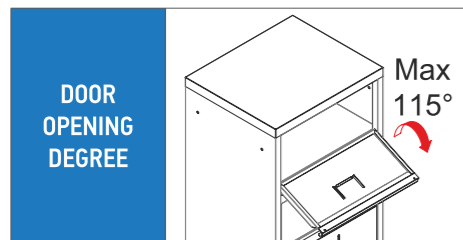

Monoblock



Powder Coated



Key Lock



Cleaning



Warranty



view				
catalogue code	FDC.5	FDC.10	FDC/L.5	FDC/L.10
production code	152M0105-00001	152M0105-00002	152M0105-00003	152M0105-00004
no of door	5	10	5	10
closure	magnetic	magnetic	locked	locked
height (mm)	1035	1980	1035	1980
width (mm)	410	410	410	410
depth (mm)	345	345	345	345

FEATURES

- » Durable Welded Metal Construction
- » Electrostatic Powder Coating
- » Ideal for Home-Offices
- » Short and Tall Models
- » On Wheels
- » Plastic Handles
- » Drawers on Telescopic Slides
- » Suspension File Support in Deep Drawer
- » 2.000 Differs Camlock with 2 Keys
- » Key Duplicate Support
- » Masterkey Support
- » Packaging: Nylon Bag + Corrugated Carton

STANDARD COLORS FOR THIS RANGE



- » Non-standard colors are available with price difference (extra charge)
- » Production codes are referring items completely in color Grey 7035

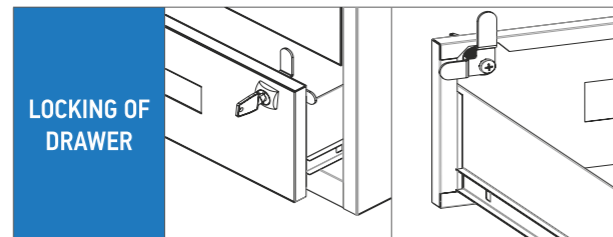
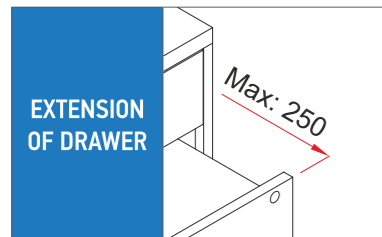

Monoblock



Powder Coated



Key Lock

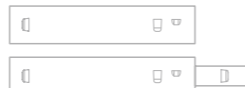

Telescopic Drawer slide



Castor / Wheel



Suspension File



Cleaning



Warranty



view						
catalogue code	HF2.(1B+1K)	HF2.(2B)	HF3.(3K)	HF3.(1B+2K)	HF4.(4K)	HF4.(4B)
production code	152M0111-00001	152M0111-00002	152M0111-00003	152M0111-00004	152M0111-00005	152M0111-00006
no of drawers	1 deep + 1 shallow	2 deep	3 shallow	1 deep + 2 shallow	4 shallow	4 deep
height (mm)	535	685	535	685	685	1280
width (mm)	400	400	400	400	400	400
depth (mm)	400	400	400	400	400	400
wheel	included	n/a	included	n/a	n/a	n/a
suspension file size	A4	A4	NA	A4	NA	A4

FEATURES

- » Durable Welded Metal Construction
- » Electrostatic Powder Coating
- » 25 mm Wooden Top Models
- » On Wheels
- » Full Size Gooseneck Handle
- » Drawers on Full-Extension Telescopic Slides
- » Suspension File Support in Deep Drawer
- » Adjustable Suspension File Bar in Deep Drawer
- » Plastic Dividers on Shallow Drawers
- » Central Locking System
- » 2.000 Differs Square Head Pedestal Lock with 2 Keys
- » Key Duplicate Support
- » Masterkey Support
- » Packaging: Nylon Bag + Corrugated Carton

OPTIONAL

- » 15 mm Metal Top Models
- » Pen Tray for Standard Models
- » Wooden Front Drawers
- » Wheel Combination Lock

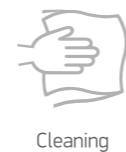
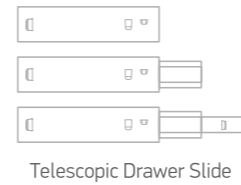
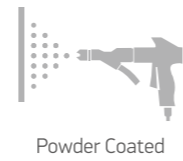
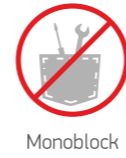

STANDARD METAL COLORS FOR THIS RANGE



STANDARD MELAMINE COLORS FOR THIS RANGE



- » Non-standard colors are available with price difference (extra charge)
- » Production codes are referring items completely in color Grey 7035

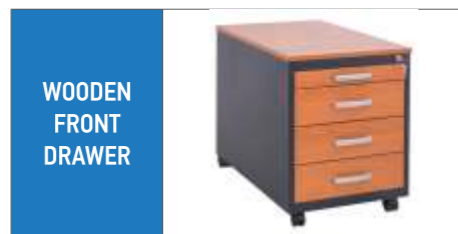

	STANDARD MODEL		+1 PEN TRAY DRAWER MODEL	
view				
catalogue code	MPG/2.5346.8	MPG/3.5346.8	MPG/2+1.5346.8	MPG/3+1.5346.8
production code	152M0112-00001	152M0112-00002	152M0112-00003	152M0112-00004
no of drawers	1 deep + 1 shallow	3 shallow	1 deep + 1 shallow + 1 pen drawer	3 shallow + 1 pen drawer
top	25 mm wood	25 mm wood	25 mm wood	25 mm wood
height (mm)	620	620	620	620
width (mm)	460	460	460	460
depth (mm)	785	785	785	785
suspension file size	LETTER+A4+FOLIO+FS	NA	LETTER+A4+FOLIO+FS	NA

- » ITEMS ARE AVAILABLE IN 400 mm WIDTH BASED ON REQUEST & QUANTITY
- » ITEMS ARE AVAILABLE IN 585 mm DEPTH BASED ON REQUEST & QUANTITY
- » ITEMS ARE AVAILABLE IN METAL TOP BASED ON REQUEST & QUANTITY
- » ITEMS ARE AVAILABLE IN WOODEN DRAWER FRONTS BASED ON REQUEST & QUANTITY

FEATURES

- » Durable Welded Metal Construction
- » Electrostatic Powder Coating
- » 25 mm Wooden Top Models
- » On Wheels
- » Side Handle
- » Drawers on Full-Extension Telescopic Slides
- » Suspension File Support in Deep Drawer
- » Adjustable Suspension File Bar in Deep Drawer
- » Plastic Dividers on Shallow Drawers
- » Central Locking System
- » 2.000 Differs Square Head Pedestal Lock with 2 Keys
- » Key Duplicate Support
- » Masterkey Support
- » Packaging: Nylon Bag + Corrugated Carton

OPTIONAL

- » 15 mm Metal Top Models
- » Pen Tray for Standard Models
- » Wooden Front Drawers
- » Wheel Combination Lock



Monoblock

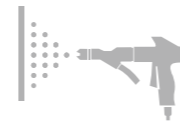

Powder Coated



Key Lock

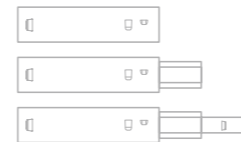

Telescopic Drawer Slide



Castor / Wheel

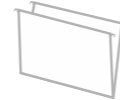

Suspension File



Cleaning



Warranty



STANDARD METAL COLORS FOR THIS RANGE



STANDARD MELAMINE COLORS FOR THIS RANGE



- » Non-standard colors are available with price difference (extra charge)
- » Production codes are referring items completely in color Grey 7035



METAL TOP

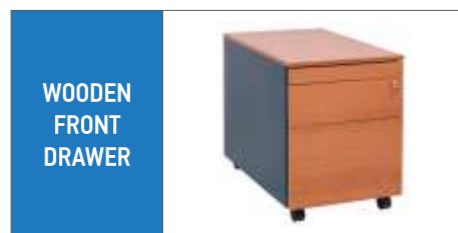

WOODEN FRONT DRAWER



WHEEL COMBINATOR LOCK

	STANDARD MODEL		+1 PEN TRAY DRAWER MODEL	
view				
catalogue code	MPS/2.5346.8	MPS/3.5346.8	MPS/2+1.5346.8	MPS/3+1.5346.8
production code	152M0112-00005	152M0112-00006	152M0112-00007	152M0112-00008
no of drawers	1 deep + 1 shallow	3 shallow	1 deep + 1 shallow + 1 pen drawer	3 shallow + 1 pen drawer
top	25 mm wood	25 mm wood	25 mm wood	25 mm wood
height (mm)	620	620	620	620
width (mm)	460	460	460	460
depth (mm)	785	785	785	785
suspension file size	LETTER+A4+FOLIO+FS	NA	LETTER+A4+FOLIO+FS	NA

- » ITEMS ARE AVAILABLE IN 400 mm WIDTH BASED ON REQUEST & QUANTITY
- » ITEMS ARE AVAILABLE IN 585 mm DEPTH BASED ON REQUEST & QUANTITY
- » ITEMS ARE AVAILABLE IN METAL TOP BASED ON REQUEST & QUANTITY
- » ITEMS ARE AVAILABLE IN WOODEN DRAWER FRONTS BASED ON REQUEST & QUANTITY

FEATURES

- » Durable Metal Frame Construction
- » Electrostatic Powder Coating
- » Pedestal Fixing Holes on Legs *
- » Levelling Feet
- » Drawer Blocks Combination *
- » 25 mm Wooden Top
- » 2 mm Edgebanding
- » Easy Assembly
- » Packaging: Flatpack in Corrugated Carton

OPTIONAL

- » Metal Side and Front Panels
- » Middle Panels
- » CPU Holder
- » **Not available on PC Corners and Wing Tables**

STANDARD METAL COLORS FOR THIS RANGE



STANDARD MELAMINE COLORS FOR THIS RANGE



- » Non-standard colors are available with price difference (extra charge)
- » **Production codes are referring items completely in color Grey 7035**



Flatpack

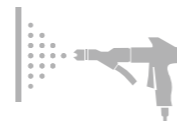

Powder Coated



Key Lock

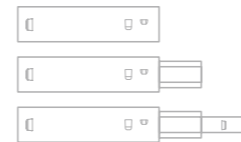

Telescopic Drawer Slide

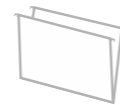

Suspension File



Cleaning



Warranty



DESKS				
view	DESKS			
catalogue code	production code	drawer blocks capacity	item	size mm (w*d*h)
ODK.128.(0)	152M0310-00001	1 block	office desk no drawer	1200*800*750
ODK.148.(0)	152M0310-00002	1 block	office desk no drawer	1400*800*750
ODK.168.(0)	152M0310-00003	2 blocks	office desk no drawer	1600*800*750
ODK.188.(0)	152M0310-00004	2 blocks	office desk no drawer	1800*800*750
ODK.208.(0)	152M0310-00005	2 blocks	office desk no drawer	2000*800*750

» ITEMS ARE AVAILABLE IN 600 mm DEPTH BASED ON REQUEST & QUANTITY

	G/H - STANDARD MODEL			G/H - +1 PEN TRAY DRAWER MODEL		
view						
catalogue code	DPG/1.2246.8	DPG/2.5346.8	DPG/3.5346.8	DPG/1+1.2646.8	DPG/2+1.5346.8	DPG/3+1.5346.8
production code	152M0112-00009	152M0112-00010	152M0112-00011	152M0112-00012	152M0112-00013	152M0112-00014
no of drawers	1 shallow	1 deep + 1 shallow	3 shallow	1 shallow + pen drawer	1 deep + 1 shallow + 1 pen drawer	3 shallow + 1 pen drawer
height (mm)	225	535	535	268	535	535
width (mm)	460	460	460	460	460	460
depth (mm)	785	785	785	785	785	785
suspension file size	NA	LETTER+A4+FOLIO+FS	NA	NA	LETTER+A4+FOLIO+FS	NA

	S/H - STANDARD MODEL			S/H - +1 PEN TRAY DRAWER MODEL		
view						
catalogue code	DPS/1.1846.8	DPS/2.5346.8	DPS/3.5346.8	DPS/1+1.2246.8	DPS/2+1.5346.8	DPS/3+1.5346.8
production code	152M0112-00015	152M0112-00016	152M0112-00017	152M0112-00018	152M0112-00019	152M0112-00020
no of drawers	1 shallow	1 deep + 1 shallow	3 shallow	1 shallow + pen drawer	1 deep + 1 shallow + 1 pen drawer	3 shallow + 1 pen drawer
height (mm)	180	535	535	225	535	535
width (mm)	460	460	460	460	460	460
depth (mm)	785	785	785	785	785	785
suspension file size	NA	LETTER+A4+FOLIO+FS	NA	NA	LETTER+A4+FOLIO+FS	NA

- » ITEMS ARE AVAILABLE IN 400 mm WIDTH BASED ON REQUEST & QUANTITY
- » ITEMS ARE AVAILABLE IN 585 mm DEPTH BASED ON REQUEST & QUANTITY
- » ITEMS ARE AVAILABLE IN WOODEN DRAWER FRONTS BASED ON REQUEST & QUANTITY

	CPU HOLDER	
view		
catalogue code	CPH/SD.5380	
production code	152M0112-00021	
no of door	1 shutter door	
height (mm)	535	
width (mm)	400	
depth (mm)	785	
compartment size	NA	



PANELS - SIDE & FRONT				
view				
catalogue code	production code	item	for desks	size mm (H*L)
SIP/O.80	152M9915-00001	side panel	800 mm deep	535*727
FRP/O.120	152M9915-00002	front panel	1200 mm wide	535*1127
FRP/O.140	152M9915-00003	front panel	1400 mm wide	535*1327
FRP/O.160	152M9915-00004	front panel	1600 mm wide	535*1527
FRP/O.180	152M9915-00005	front panel	1800 mm wide	535*1727
FRP/O.200	152M9915-00006	front panel	2000 mm wide	535*1927

PANELS - MIDDLE				
view				
catalogue code	production code	item	for desks	size mm (H*L)
MIP/O.120	152M9915-00007	middle panel	1200 mm wide	300*1200
MIP/O.140	152M9915-00008	middle panel	1400 mm wide	300*1400
MIP/O.160	152M9915-00009	middle panel	1600 mm wide	300*1600
MIP/O.180	152M9915-00010	middle panel	1800 mm wide	300*1800
MIP/O.200	152M9915-00011	middle panel	2000 mm wide	300*2000

CONNECTION PART			
view			
catalogue code	production code	item	size mm
LDKCP/80	152M9915-00012	connection part for depth of desk	800(D)
CP/DT	152M9915-00013	connection part for length of desk	400*850

PC CORNER & WING TABLES			
view			
catalogue code	production code	item	size mm
MTB.PC.128	152M0309-00001	pc corner	1200-1200*800*750(h)
MTB.W.R.188	152M0311-00001	wing right	1800*1200*800-800*750(h)
MTB.W.L.188	152M0311-00002	wing left	1800*1200*800-800*750(h)
MTB.W.R.208	152M0311-00003	wing right	2000*1200*800-800*750(h)
MTB.W.L.208	152M0311-00004	wing left	2000*1200*800-800*750(h)

FEATURES

- » Durable Welded Metal Construction
- » Electrostatic Powder Coating
- » 25 mm Wooden Top
- » Levelling Feet
- » Full Size Gooseneck Handle
- » Drawers on Full-Extension Telescopic Slides
- » Suspension File Support in Deep Drawer
- » Adjustable Suspension File Bar in Deep Drawer
- » Plastic Dividers on Shallow Drawers
- » Central Locking System
- » 2.000 Differs Square Head Pedestal Lock with 2 Keys
- » Key Duplicate Support
- » Masterkey Support
- » Packaging: Nylon Bag + Corrugated Carton

OPTIONAL

- » Pen Tray for Standard Models
- » Wooden Front Drawers
- » Wheel Combination Lock

STANDARD METAL COLORS FOR THIS RANGE



STANDARD MELAMINE COLORS FOR THIS RANGE



- » Non-standard colors are available with price difference (extra charge)
- » Production codes are referring items completely in color Grey 7035

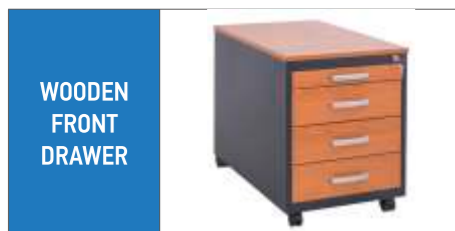

WOODEN FRONT DRAWER



WHEEL COMBINATOR LOCK



Monoblock



Powder Coated



Key Lock

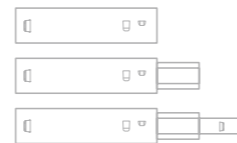

Telescopic Drawer Slide



Suspension File



Cleaning



Warranty



	G/H - STANDARD MODEL			G/H - +1 PEN TRAY DRAWER MODEL		
view						
catalogue code	DNPG/2.7246.8	DNPG/3.7246.8	DNPG/4.7246.8	DNPG/2+1.7246.8	DNPG/3+1.7246.8	DNPG/4+1.7246.8
production code	152M0112-00023	152M0112-00024	152M0112-00025	152M0112-00026	152M0112-00027	152M0112-00028
no of drawers	2 deep	1 deep + 2 shallow	4 shallow	2 deep + 1 pen drawer	1 deep + 2 shallow + 1 pen drawer	4 shallow + 1 pen drawer
top	25 mm wood	25 mm wood	25 mm wood	25 mm wood	25 mm wood	25 mm wood
height (mm)	750	750	750	750	750	750
width (mm)	460	460	460	460	460	460
depth (mm)	785	785	785	785	785	785
suspension file size	LETTER+A4+FOLIO+FS	LETTER+A4+FOLIO+FS	NA	LETTER+A4+FOLIO+FS	LETTER+A4+FOLIO+FS	NA

- » ITEMS ARE AVAILABLE IN 400 mm WIDTH BASED ON REQUEST & QUANTITY
- » ITEMS ARE AVAILABLE IN 585 mm DEPTH BASED ON REQUEST & QUANTITY
- » ITEMS ARE AVAILABLE IN WOODEN DRAWER FRONTS BASED ON REQUEST & QUANTITY

FEATURES

- » Durable Welded Metal Construction
- » Electrostatic Powder Coating
- » 25 mm Wooden Top
- » Levelling Feet
- » Side Handle
- » Drawers on Full-Extension Telescopic Slides
- » Suspension File Support in Deep Drawer
- » Adjustable Suspension File Bar in Deep Drawer
- » Plastic Dividers on Shallow Drawers
- » Central Locking System
- » 2.000 Differs Square Head Pedestal Lock with 2 Keys
- » Key Duplicate Support
- » Masterkey Support
- » Packaging: Nylon Bag + Corrugated Carton

OPTIONAL

- » Pen Tray for Standard Models
- » Wooden Front Drawers
- » Wheel Combination Lock

STANDARD METAL COLORS FOR THIS RANGE



STANDARD MELAMINE COLORS FOR THIS RANGE



- » Non-standard colors are available with price difference (extra charge)
- » Production codes are referring items completely in color Grey 7035

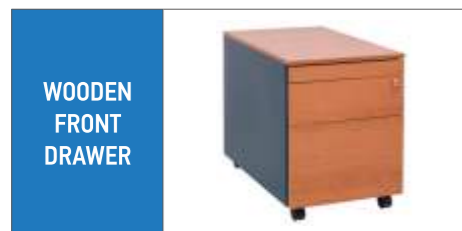

WOODEN FRONT DRAWER



WHEEL COMBINATOR LOCK



Monoblock

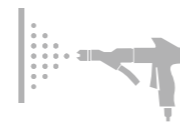

Powder Coated



Key Lock

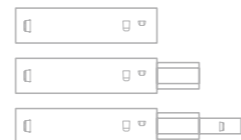

Telescopic Drawer Slide

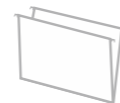

Suspension File



Cleaning



Warranty



	S/H - STANDARD MODEL			S/H - +1 PEN TRAY DRAWER MODEL		
view						
catalogue code	DNPS/2.7246.8	DNPS/3.7246.8	DNPS/4.7246.8	DNPS/2+1.7246.8	DNPS/3+1.7246.8	DNPS/4+1.7246.8
production code	152M0112-00029	152M0112-00030	152M0112-00031	152M0112-00032	152M0112-00033	152M0112-00034
no of drawers	2 deep	1 deep + 2 shallow	4 shallow	2 deep + 1 pen drawer	1 deep + 2 shallow + 1 pen drawer	4 shallow + 1 pen drawer
top	25 mm wood	25 mm wood	25 mm wood	25 mm wood	25 mm wood	25 mm wood
height (mm)	750	750	750	750	750	750
width (mm)	460	460	460	460	460	460
depth (mm)	785	785	785	785	785	785
suspension file size	LETTER+A4+FOLIO+FS	LETTER+A4+FOLIO+FS	NA	LETTER+A4+FOLIO+FS	LETTER+A4+FOLIO+FS	NA

- » ITEMS ARE AVAILABLE IN 400 mm WIDTH BASED ON REQUEST & QUANTITY
- » ITEMS ARE AVAILABLE IN 585 mm DEPTH BASED ON REQUEST & QUANTITY
- » ITEMS ARE AVAILABLE IN WOODEN DRAWER FRONTS BASED ON REQUEST & QUANTITY

**TABLES &
CHAIRS**

FEATURES

- » Durable Metal Frame Construction
- » Electrostatic Powder Coating
- » Square Tube Legs
- » Levelling Feet under Tubes
- » 25 mm Wooden Top
- » 2 mm Edgebanding
- » Easy Assembly
- » Packaging: Flatpack in Corrugated Carton
- » Delivery on Pallet

OPTIONAL

- » Chrome-Plated Legs

STANDARD METAL COLORS FOR THIS RANGE



STANDARD MELAMINE COLORS FOR THIS RANGE



- » Non-standard colors are available with price difference (extra charge)
- » Production codes are referring items completely in color Grey 7035



- Flatpack
- Powder Coated
- E1
- FSC
- Cleaning
- 2 YEARS WARRANTY
- Warranty

SQUARE TABLES			
view			
catalogue code	MTB.S.66	MTB.S.77	MTB.S.88
production code	152M0320-00001	152M0320-00002	152M0320-00003
top shape	square	square	square
leg type	square	square	square
height (mm)	750	750	750
width (mm)	600	700	800
depth (mm)	600	700	800



view						
RECTANGLE TABLES - 600 mm DEEP						
catalogue code	MTB.R.106	MTB.R.126	MTB.R.146	MTB.R.166	MTB.R.186	MTB.R.206
production code	152M0320-00004	152M0320-00005	152M0320-00006	152M0320-00007	152M0320-00008	152M0320-00009
top shape	rectangle	rectangle	rectangle	rectangle	rectangle	rectangle
leg type	square	square	square	square	square	square
height (mm)	750	750	750	750	750	750
width (mm)	1000	1200	1400	1600	1800	2000
depth (mm)	600	600	600	600	600	600

RECTANGLE TABLES - 700 mm DEEP						
catalogue code	MTB.R.107	MTB.R.127	MTB.R.147	MTB.R.167	MTB.R.187	MTB.R.207
production code	152M0320-00010	152M0320-00011	152M0320-00012	152M0320-00013	152M0320-00014	152M0320-00015
top shape	rectangle	rectangle	rectangle	rectangle	rectangle	rectangle
leg type	square	square	square	square	square	square
height (mm)	750	750	750	750	750	750
width (mm)	1000	1200	1400	1600	1800	2000
depth (mm)	700	700	700	700	700	700

RECTANGLE TABLES - 800 mm DEEP						
catalogue code	MTB.R.108	MTB.R.128	MTB.R.148	MTB.R.168	MTB.R.188	MTB.R.208
production code	152M0320-00016	152M0320-00017	152M0320-00018	152M0320-00019	152M0320-00020	152M0320-00021
top shape	rectangle	rectangle	rectangle	rectangle	rectangle	rectangle
leg type	square	square	square	square	square	square
height (mm)	750	750	750	750	750	750
width (mm)	1000	1200	1400	1600	1800	2000
depth (mm)	800	800	800	800	800	800

QUARTER TABLES			
view			
catalogue code	MTB.Q.66	MTB.Q.77	MTB.Q.88
production code	152M0303-00001	152M0303-00002	152M0303-00003
top shape	quarter	quarter	quarter
leg type	square	square	square
height (mm)	750	750	750
width (mm)	600	700	800
depth (mm)	600	700	800



TRAPEZOID TABLES			
view			
catalogue code	MTB.T.126	MTB.T.147	MTB.T.168
production code	152M0307-00001	152M0307-00002	152M0307-00003
top shape	trapezoid	trapezoid	trapezoid
leg type	square	square	square
height (mm)	750	750	750
width (mm)	1200-600	1400-700	1600-800
depth (mm)	600	700	800



HALF MOON TABLES			
view			
catalogue code	MTB.M.126	MTB.M.147	MTB.M.168
production code	152M0304-00001	152M0304-00002	152M0304-00003
top shape	half moon	half moon	half moon
leg type	square	square	square
height (mm)	750	750	750
width (mm)	1200	1400	1600
depth (mm)	600	700	800



CRESCENT & HALF BOAT & TRIANGLE			
view			
catalogue code	MTB.C.126	MTB.HB.126	MTB.G.88
production code	152M0306-00001	152M0301-00001	152M0308-00001
top shape	crescent	half boat	triangle
leg type	square	square	square
height (mm)	750	750	750
width (mm)	1200-1200	1200-1200	800-800
depth (mm)	600	600	1130



CIRCLE TABLES			
view			
catalogue code	MTB.CR.80	MTB.CR.100	MTB.CR.120
production code	152M0305-00001	152M0305-00002	152M0305-00003
top shape	circle	circle	circle
leg type	square	square	square
height (mm)	750	750	750
ø (mm)	800	1000	1200



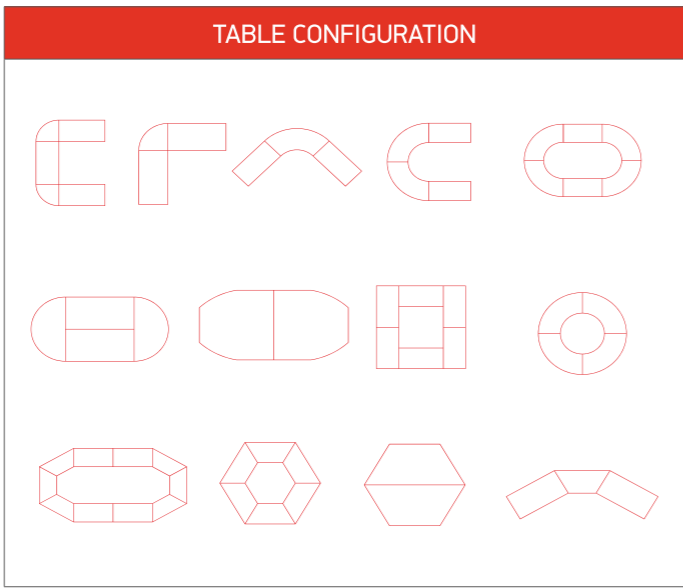

MAILROOM FURNITURE

MAIL BOX CUPBOARDS - MASTER DOOR FEATURES

- » Durable Welded Metal Construction
- » Electrostatic Powder Coating
- » Wall Mounting Hole on Rear Top
- » Anti-Noise Plastic Buffers on Doors
- » Locked and Mastered Doors
- » Packaging: Nylon Bag + Corrugated Carton

MAIL BOX CUPBOARDS - SHORT DOOR FEATURES

- » Durable Welded Metal Construction
- » Electrostatic Powder Coating
- » Wall Mounting Hole on Rear Top
- » Can be Bolted Side by Side
- » Anti-Noise Plastic Buffers on Doors
- » Short Doors with Magnetic Catch
- » Packaging: Nylon Bag + Corrugated Carton

OPTIONAL

- » Locked Doors

MAIL BOX CUPBOARDS - MULTIPLE DOOR FEATURES

- » Durable Welded Metal Construction
- » Electrostatic Powder Coating
- » Wall Mounting Hole on Rear Top
- » Anti-Noise Plastic Buffers on Doors
- » Locked Doors
- » Open Bottom Cases
- » Packaging: Nylon Bag + Corrugated Carton

STANDARD COLORS FOR THIS RANGE

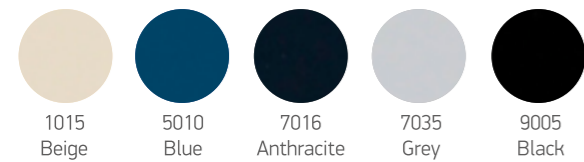

- » Non-standard colors are available with price difference (extra charge)
- » Production codes are referring items completely in color Grey 7035



Monoblock

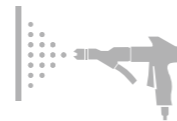

Powder Coated



Key Lock



Cleaning



Warranty



view									
range	SHORT DOOR		SHORT DOOR		MASTER DOOR	MULTIPLE DOOR		MULTIPLE DOOR	
catalogue code	MBC/SD.8	MBC/SD.10	MBC/SD/L.8	MBC/SD/L.10	MBC.10	MBC/D20-OC2	MBC/D20-OC2-TS1	MBC/D40-OC4	MBC/D40-OC4-TS2
production code	152M0502-00001	152M0502-00002	152M0502-00003	152M0502-00004	152M0501-00001	152M0504-00001	152M0504-00002	152M0504-00003	152M0504-00004
no of door	8 [1x8]	10 [1x10]	8 [1x8]	10 [1x10]	10 [1x10]	20 [2x10]	20 [2x10]	40 [4x10]	40 [4x10]
open case	n/a	n/a	n/a	n/a	n/a	2 [1x2]	2 [1x2]	4 [2x2]	4 [2x2]
roll-out shelf	n/a	n/a	n/a	n/a	n/a	n/a	1	n/a	2
closure	magnetic	magnetic	locked	locked	locked	locked	locked	locked	locked
height (mm)	1462	1800	1462	1800	1800	1800	1800	1800	1800
width (mm)	315	315	315	315	400	600	600	1170	1170
depth (mm)	500	500	500	500	500	500	500	500	500

MAIL SORTING STATION FEATURES

- » Durable Welded Metal Construction
- » Electrostatic Powder Coating
- » Combination of Module & Module Riser and Base Cupboard
- » Module Pockets Suitable for C4 Envelope
- » Packaging: Nylon Bag + Corrugated Carton

MAIL SORTING CUPBOARDS FEATURES

- » Durable Welded Metal Construction
- » Electrostatic Powder Coating
- » Wall Mounting Hole on Rear Top
- » Sorting Cases
- » Roll-Out Shelf
- » Packaging: Nylon Bag + Corrugated Carton

MAIL BAG HOLDERS FEATURES

- » Durable Tube Construction
- » Electrostatic Powder Coating
- » Stationary or Mobile Models
- » Adjustable Hooks for Bags
- » Easy Assembly
- » Packaging: Flatpack in Corrugated Carton

STANDARD METAL COLORS FOR THIS RANGE



7035
Grey

STANDARD MELAMINE COLORS FOR THIS RANGE



Beech



Grey

STANDARD SHUTTER COLORS FOR THIS RANGE



Beech



Grey

- » Non-standard colors are available with price difference (extra charge)
- » Production codes are referring items completely in color Grey 7035



Monoblock

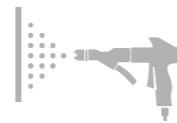

Powder Coated



Key Lock



Warranty



MAIL SORTING STATION			
view			
catalogue code	MSM.5(20)	MRB.150	MSBC/SD.15080
production code	152M0504-00005	152M0504-00006	152M0504-00007
item name	module	module riser	shutter door base cupboard
description	5 cases / 20 pockets	open	25 mm top & 1 shelf
height (mm)	350	350	750
width (mm)	1500	1500	1500
depth (mm)	350	350	800



MAIL SORTING CUPBOARDS						
view						
catalogue code	MSU/SC20-BC2	MSU/SC20-BC2-TS1	MSU/SC40-BC4	MSU/SC40-BC4-TS2	MSC/O/3C-24	MSC/CTO/3C-15
production code	152M0504-00008	152M0504-00009	152M0504-00010	152M0504-00011	152M0504-00012	152M0504-00013
no of door	n/a	n/a	n/a	n/a	n/a	bottom swing doors
no of case	20S [2x10] & 2B (1x2)	20S [2x10] & 2B (1x2)	40S [4x10] & 4B (2x2)	48S [4x10] & 4B (2x2)	3 columns & 24 cases	top 3 columns & 15 cases
roll-out shelf	n/a	1	n/a	2	n/a	1
height (mm)	1800	1800	1800	1800	1950	1950
width (mm)	600	600	1170	1170	925	925
depth (mm)	500	500	500	500	422	422

MAIL BAG HOLDER				
view				
catalogue code	MBH.2	MBH/M.2	MBH.3	MBH/M.3
production code	152M0505-00001	152M0505-00002	152M0505-00003	152M0505-00004
capacity	2 bags	2 bags	3 bags	3 bags
moving	stationary	mobile	stationary	mobile
height (mm)	1220	1320	1220	1320
width (mm)	890	890	1270	1270
depth (mm)	460	460	460	460

WARDROBES & LOCKERS

FEATURES

- » Durable Welded Metal Construction
- » Electrostatic Powder Coating
- » Wall Mounting Holes on Rear Top
- » Top Shelf with Coat Rail and Hook in Each Section
- » Reinforced Doors with Concealed Hinges and Anti-Noise Plastic Buffers
- » Stamped Label Holder on Doors
- » Louvered Doors for Air Circulation
- » 2.000 Differs Round Head Camlock with 2 Keys
- » Key Duplicate Support
- » Masterkey Support
- » Packaging: Nylon Bag + Corrugated Carton

OPTIONAL

- » Bolting Holes on Sides to Connect Cupboards [Fixing Kit is Not Included]
- » Bottom Shelf
- » Perforated Door Types
- » Swing Door Model
- » Envelope Hole on Doors
- » Coin Lock
- » Keypad Combination Lock
- » Wheel Combination Lock
- » 2.000 Differs 3 Point Round Head Camlock with 2 Keys
- » Latchlock
- » Flush Latchlock
- » 3 Point Latchlock
- » 200 mm Sloping Roof [Fixing by Bolt]
- » 500 mm Top Cupboard [Fixing by Bolt]
- » 100 mm Base [Fixing by Bolt]
- » 100 mm Feet [Welded or Fixing by Bolt on Request]
- » 100 mm Framed Feet [Fixing by Bolt]
- » 400 mm Bench Models [Fixing by Bolt]
- » 400 mm Base Cupboards for Single Door Models [Fixing by Bolt]
- » 400 mm Base Cupboards for Swing Door Models [Fixing by Bolt]

STANDARD COLORS FOR THIS RANGE

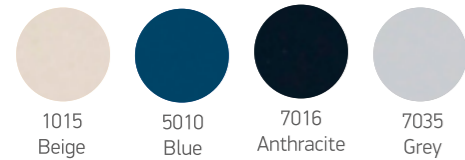

- » Non-standard colors are available with price difference (extra charge)
- » Production codes are referring items completely in color Grey 7035



Monoblock



Powder Coated



Key Lock



Aeration



Cleaning









Warranty







STANDARD				
view				
catalogue code	WRC/1.1830	WRC/2.1860	WRC/3.1890	WRC/4.18117
production code	152M0601-00001	152M0601-00002	152M0601-00003	152M0601-00004
no of door	1	2	3	4
door type	right hung	right hung	right hung	right hung
ventilation	louvered	louvered	louvered	louvered
height (mm)	1800	1800	1800	1800
width (mm)	315	600	885	1170
depth (mm)	500	500	500	500

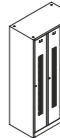
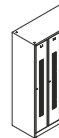

VERSION 1				
view				
catalogue code	WRC/1.1830.V1	WRC/2.1860.V1	WRC/3.1890.V1	WRC/4.18117.V1
production code	152M0601-00005	152M0601-00006	152M0601-00007	152M0601-00008
no of door	1	2	3	4
door type	right hung	right hung	right hung	right hung
ventilation	square perforated	square perforated	square perforated	square perforated
height (mm)	1800	1800	1800	1800
width (mm)	315	600	885	1170
depth (mm)	500	500	500	500

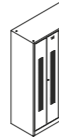
VERSION 4				
view				
catalogue code	WRC/1.1830.V4	WRC/2.1860.V4	WRC/3.1890.V4	WRC/4.18117.V4
production code	152M0601-00013	152M0601-00014	152M0601-00015	152M0601-00016
no of door	1	2	3	4
door type	right hung	right hung	right hung	right hung
ventilation	round perforated	round perforated	round perforated	round perforated
height (mm)	1800	1800	1800	1800
width (mm)	315	600	885	1170
depth (mm)	500	500	500	500

SWING DOORS V2 & V3				
view				
catalogue code	WRC/2.1860.V2	WRC/4.18117.V2	WRC/2.1860.V3	WRC/4.18117.V3
production code	152M0601-00009	152M0601-00010	152M0601-00011	152M0601-00012
no of door	2	4	2	4
door type	swing	swing	swing	swing
ventilation	louvered	louvered	square perforated	square perforated
height (mm)	1800	1800	1800	1800
width (mm)	600	1170	600	1170
depth (mm)	500	500	500	500

VERSION 5		
view		
catalogue code	WRC/2.1860.V5	WRC/4.18117.V5
production code	152M0601-00017	152M0601-00018
no of door	2	4
door type	swing	swing
ventilation	round perforated	round perforated
height (mm)	1800	1800
width (mm)	600	1170
depth (mm)	500	500

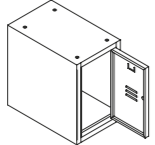
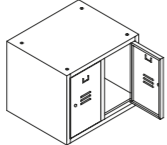
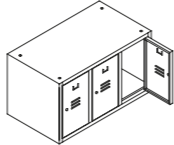
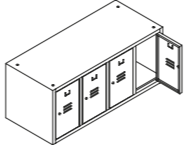

TOP CUPBOARDS for C/I *

view				
catalogue code	WTC/1.5030	WTC/2.5060	WTC/3.5090	WTC/4.50117
production code	152M9909-00001	152M9909-00002	152M9909-00003	152M9909-00004
no of door	1	2	3	4
door type	standard	standard	standard	standard
ventilation	louvered	louvered	louvered	louvered
height (mm)	500	500	500	500
width (mm)	315	600	885	1170
depth (mm)	500	500	500	500

* Should be ordered together with the main cupboards

BOTTOM CUPBOARDS for C/I *

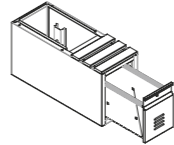
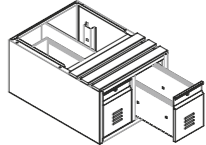
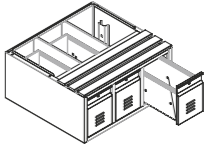
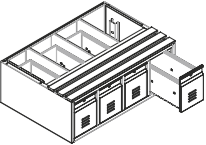
view				
catalogue code	WBC/1DW.4030	WBC/2DW.4060	WBC/3DW.4090	WBC/4DW.40117
production code	152M9909-00005	152M9909-00006	152M9909-00007	152M9909-00008
model	1 drawer	2 drawers	3 drawers	4 drawers
ventilation	louvered	louvered	louvered	louvered
height (mm)	400	400	400	400
width (mm)	315	600	885	1170
depth (mm)	800	800	800	800

* Should be ordered together with the main cupboards



BASE CUPBOARDS for C/I - Swing Door Models *		
view		
catalogue code	WBC/1DW.4050	WBC/1DW.4060
production code	152M9909-00009	152M9909-00010
model	1 drawer	1 drawer
ventilation	louvered	louvered
height (mm)	400	400
width (mm)	500	600
depth (mm)	800	800

MOBILE HANGED DIVIDER			
view			
catalogue code	MHD/WRC.180(1.1)	MHD/WRC/BS.180(1.1)	MHD/WRC.180(1.2)
production code	152M9909-00037	152M9909-00038	152M9909-00039
for	1x1	1x1 with Bottom Shelf	1x2
height (mm)	1200	880	670
depth (mm)	400	400	400

* Should be ordered together with the main cupboards

FEATURES

- » Durable Welded Metal Construction
- » Electrostatic Powder Coating
- » Wall Mounting Holes on Rear Top
- » Top Shelf with Coat Rail and Hook in Each Section
- » Reinforced Doors with Concealed Hinges and Anti-Noise Plastic Buffers
- » Stamped Label Holder on Doors
- » Louvered Doors for Air Circulation
- » 2.000 Differs Round Head Camlock with 2 Keys
- » Key Duplicate Support
- » Masterkey Support
- » Packaging: Nylon Bag + Corrugated Carton

OPTIONAL

- » Bolting Holes on Sides to Connect Cupboards [Fixing Kit is Not Included]
- » Bottom Shelf
- » Perforated Door Types
- » Envelope Hole on Doors
- » Coin Lock
- » Keypad Combination Lock
- » Wheel Combination Lock
- » 2.000 Differs 3 Point Round Head Camlock with 2 Keys
- » Latchlock
- » Flush Latchlock
- » 3 Point Latchlock
- » 200 mm Sloping Roof [Fixing by Bolt]
- » 500 mm Top Cupboard [Fixing by Bolt]
- » 100 mm Base [Fixing by Bolt]
- » 100 mm Feet [Welded or Fixing by Bolt on Request]
- » 100 mm Framed Feet [Fixing by Bolt]
- » 400 mm Bench Models [Fixing by Bolt]
- » 400 mm Base Cupboards for Single Door Models [Fixing by Bolt]

STANDARD COLORS FOR THIS RANGE

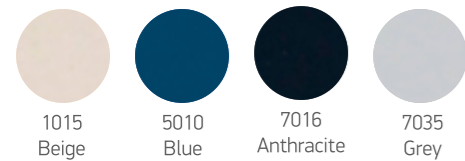

- » Non-standard colors are available with price difference (extra charge)
- » Production codes are referring items completely in color Grey 7035



DOOR OPENING DEGREE



Monoblock



Powder Coated



Key Lock



Aeration



Cleaning



Warranty

STANDARD			
view			
catalogue code	WRD/1.1840	WRD/2.1880	WRD/3.1812
production code	152M0601-00019	152M0601-00020	152M0601-00021
no of door	1	2	3
door type	right hung	right hung	right hung
ventilation	louvered	louvered	louvered
height (mm)	1800	1800	1800
width (mm)	415	800	1185
depth (mm)	500	500	500

VERSION 1			
view			
catalogue code	WRD/1.1840.V1	WRD/2.1880.V1	WRD/3.1812.V1
production code	152M0601-00022	152M0601-00023	152M0601-00024
no of door	1	2	3
door type	right hung	right hung	right hung
ventilation	square perforated	square perforated	square perforated
height (mm)	1800	1800	1800
width (mm)	415	800	1185
depth (mm)	500	500	500

VERSION 4			
view			
catalogue code	WRD/1.1840.V4	WRD/2.1880.V4	WRD/3.1812.V4
production code	152M0601-00025	152M0601-00026	152M0601-00027
no of door	1	2	3
door type	right hung	right hung	right hung
ventilation	round perforated	round perforated	round perforated
height (mm)	1800	1800	1800
width (mm)	415	800	1185
depth (mm)	500	500	500

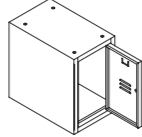
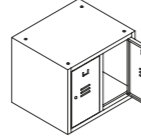
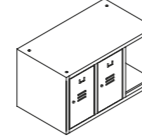

TOP CUPBOARDS for D/I *

view			
catalogue code	WTC/1.5040	WTC/2.5080	WTC/3.5012
production code	152M9909-00040	152M9909-00041	152M9909-00042
no of door	1	2	3
door type	standard	standard	standard
ventilation	louvered	louvered	louvered
height (mm)	500	500	500
width (mm)	415	800	1185
depth (mm)	500	500	500

* Should be ordered together with the main cupboards

BASE CUPBOARDS for D/I *

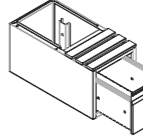
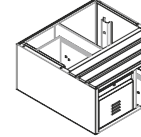
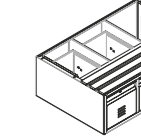
view			
catalogue code	WBC/1DW.4040	WBC/2DW.4080	WBC/3DW.4012
production code	152M9909-00043	152M9909-00044	152M9909-00045
model	1 drawer	2 drawers	3 drawers
ventilation	louvered	louvered	louvered
height (mm)	400	400	400
width (mm)	415	800	1185
depth (mm)	800	800	800

* Should be ordered together with the main cupboards

FEATURES

- » Durable Welded Metal Construction
- » Electrostatic Powder Coating
- » Wall Mounting Holes on Rear Top
- » Coat Rail with Hook in Each Section
- » Reinforced Doors with Concealed Hinges and Anti-Noise Plastic Buffers
- » Stamped Label Holder on Doors
- » Louvered Doors for Air Circulation
- » 2.000 Differs Round Head Camlock with 2 Keys
- » Key Duplicate Support
- » Masterkey Support
- » Packaging: Nylon Bag + Corrugated Carton

OPTIONAL

- » Bolting Holes on Sides to Connect Cupboards [Fixing Kit is Not Included]
- » Perforated Door Types
- » Swing Door Model
- » Coin Lock
- » Keypad Combination Lock
- » Wheel Combination Lock
- » 2.000 Differs 3 Point Round Head Camlock with 2 Keys
- » Latchlock
- » Flush Latchlock
- » 3 Point Latchlock
- » 200 mm Sloping Roof [Fixing by Bolt]
- » 100 mm Base [Fixing by Bolt]
- » 100 mm Feet [Welded or Fixing by Bolt on Request]
- » 100 mm Framed Feet [Fixing by Bolt]
- » 400 mm Bench Models [Fixing by Bolt]

STANDARD COLORS FOR THIS RANGE

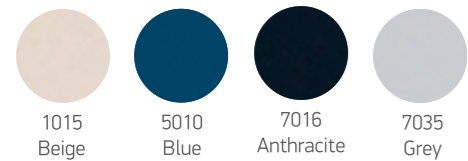

- » Non-standard colors are available with price difference (extra charge)
- » Production codes are referring items completely in color Grey 7035

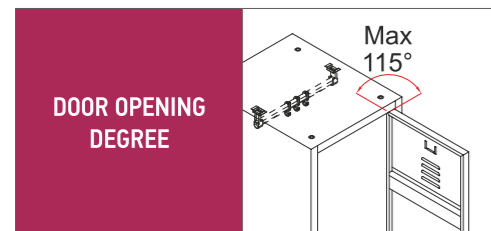

Monoblock

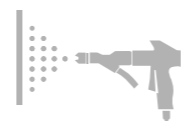

Powder Coated



Key Lock



Aeration



Cleaning



Warranty



	STANDARD			
view				
catalogue code	WRC.2(1.2).18030	WRC.4(2.2).18060	WRC.6(3.2).18090	WRC.8(4.2).180117
production code	152M0601-00036	152M0601-00037	152M0601-00038	152M0601-00039
no of door	2	4	6	8
door type	right hung	right hung	right hung	right hung
ventilation	louvered	louvered	louvered	louvered
height (mm)	1800	1800	1800	1800
width (mm)	315	600	885	1170
depth (mm)	500	500	500	500



WARDROBES & LOCKERS

WARDROBE CUPBOARDS

1/2 DOORS - 180*40 SERIES

VERSION 1

view				
catalogue code	WRC.2(1.2).18030.V1	WRC.4(2.2).18060.V1	WRC.6(3.2).18090.V1	WRC.8(4.2).180117.V1
production code	152M0601-00040	152M0601-00041	152M0601-00042	152M0601-00043
no of door	2	4	6	8
door type	right hung	right hung	right hung	right hung
ventilation	square perforated	square perforated	square perforated	square perforated
height (mm)	1800	1800	1800	1800
width (mm)	315	600	885	1170
depth (mm)	500	500	500	500

VERSION 4

view				
catalogue code	WRC.2(1.2).18030.V4	WRC.4(2.2).18060.V4	WRC.6(3.2).18090.V4	WRC.8(4.2).180117.V4
production code	152M0601-00044	152M0601-00045	152M0601-00046	152M0601-00047
no of door	2	4	6	8
door type	right hung	right hung	right hung	right hung
ventilation	round perforated	round perforated	round perforated	round perforated
height (mm)	1800	1800	1800	1800
width (mm)	315	600	885	1170
depth (mm)	500	500	500	500

STANDARD



view			
catalogue code	WRC.2(1.2).18040	WRC.4(2.2).18080	WRC.6(3.2).180120
production code	152M0601-00048	152M0601-00049	152M0601-00050
no of door	2	4	6
door type	right hung	right hung	right hung
ventilation	louvered	louvered	louvered
height (mm)	1800	1800	1800
width (mm)	415	800	1185
depth (mm)	500	500	500

VERSION 1

view			
catalogue code	WRC.2(1.2).18040.V1	WRC.4(2.2).18080.V1	WRC.6(3.2).180120.V1
production code	152M0601-00051	152M0601-00052	152M0601-00053
no of door	2	4	6
door type	right hung	right hung	right hung
ventilation	square perforated	square perforated	square perforated
height (mm)	1800	1800	1800
width (mm)	415	800	1185
depth (mm)	500	500	500



VERSION 4

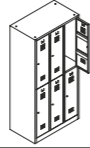
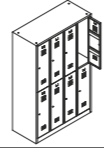

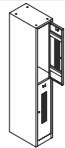
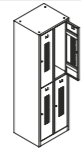
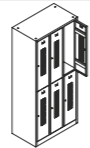
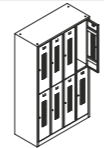
view			
catalogue code	WRC.2(1.2).18040.V4	WRC.4(2.2).18080.V4	WRC.6(3.2).180120.V4
production code	152M0601-00054	152M0601-00055	152M0601-00056
no of door	2	4	6
door type	right hung	right hung	right hung
ventilation	round perforated	round perforated	round perforated
height (mm)	1800	1800	1800
width (mm)	415	800	1185
depth (mm)	500	500	500

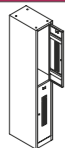
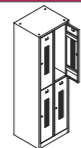
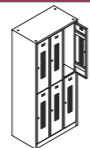
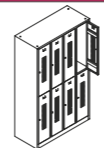

STANDARD				
view				
catalogue code	WRC.2(1.2).19530	WRC.4(2.2).19560	WRC.6(3.2).19590	WRC.8(4.2).195117
production code	152M0601-00057	152M0601-00058	152M0601-00059	152M0601-00060
no of door	2	4	6	8
door type	right hung	right hung	right hung	right hung
ventilation	louvered	louvered	louvered	louvered
height (mm)	1950	1950	1950	1950
width (mm)	315	600	885	1170
depth (mm)	500	500	500	500

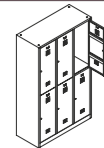
VERSION 1				
view				
catalogue code	WRC.2(1.2).19530.V1	WRC.4(2.2).19560.V1	WRC.6(3.2).19590.V1	WRC.8(4.2).195117.V1
production code	152M0601-00061	152M0601-00062	152M0601-00063	152M0601-00064
no of door	2	4	6	8
door type	right hung	right hung	right hung	right hung
ventilation	square perforated	square perforated	square perforated	square perforated
height (mm)	1950	1950	1950	1950
width (mm)	315	600	885	1170
depth (mm)	500	500	500	500

VERSION 4				
view				
catalogue code	WRC.2(1.2).19530.V4	WRC.4(2.2).19560.V4	WRC.6(3.2).19590.V4	WRC.8(4.2).195117.V4
production code	152M0601-00065	152M0601-00066	152M0601-00067	152M0601-00068
no of door	2	4	6	8
door type	right hung	right hung	right hung	right hung
ventilation	round perforated	round perforated	round perforated	round perforated
height (mm)	1950	1950	1950	1950
width (mm)	315	600	885	1170
depth (mm)	500	500	500	500

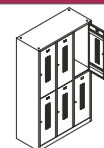
STANDARD			
view			
catalogue code	WRC.2(1.2).19540	WRC.4(2.2).19580	WRC.6(3.2).195120
production code	152M0601-00069	152M0601-00070	152M0601-00071
no of door	2	4	6
door type	right hung	right hung	right hung
ventilation	louvered	louvered	louvered
height (mm)	1950	1950	1950
width (mm)	415	800	1185
depth (mm)	500	500	500

VERSION 1			
view			
catalogue code	WRC.2(1.2).19540.V1	WRC.4(2.2).19580.V1	WRC.6(3.2).195120.V1
production code	152M0601-00072	152M0601-00073	152M0601-00074
no of door	2	4	6
door type	right hung	right hung	right hung
ventilation	square perforated	square perforated	square perforated
height (mm)	1950	1950	1950
width (mm)	415	800	1185
depth (mm)	500	500	500

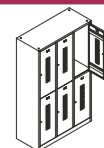
VERSION 4			
view			
catalogue code	WRC.2(1.2).19540.V4	WRC.4(2.2).19580.V4	WRC.6(3.2).195120.V4
production code	152M0601-00075	152M0601-00076	152M0601-00077
no of door	2	4	6
door type	right hung	right hung	right hung
ventilation	round perforated	round perforated	round perforated
height (mm)	1950	1950	1950
width (mm)	415	800	1185
depth (mm)	500	500	500

FEATURES

- » Durable Welded Metal Construction
- » Electrostatic Powder Coating
- » Wall Mounting Holes on Rear Top
- » Coat Rail with Hook in Each Section
- » Reinforced Doors with Concealed Hinges and Anti-Noise Plastic Buffers
- » Stamped Label Holder on Doors
- » Louvered Doors for Air Circulation
- » 2.000 Differs Round Head Camlock with 2 Keys
- » Key Duplicate Support
- » Masterkey Support
- » Packaging: Nylon Bag + Corrugated Carton

OPTIONAL

- » Bolting Holes on Sides to Connect Cupboards [Fixing Kit is Not Included]
- » Perforated Door Types
- » Swing Door Models
- » Keypad Combination Lock
- » Wheel Combination Lock
- » 2.000 Differs 3 Point Round Head Camlock with 2 Keys
- » Latchlock
- » Flush Latchlock
- » 3 Point Latchlock
- » 200 mm Sloping Roof [Fixing by Bolt]
- » 100 mm Base [Fixing by Bolt]
- » 100 mm Feet [Welded or Fixing by Bolt on Request]
- » 100 mm Framed Feet [Fixing by Bolt]
- » 400 mm Bench Models [Fixing by Bolt]

STANDARD COLORS FOR THIS RANGE

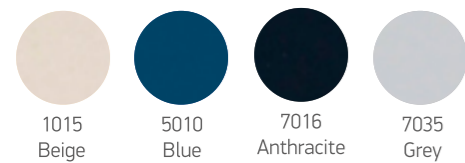

- » Non-standard colors are available with price difference (extra charge)
- » Production codes are referring items completely in color Grey 7035

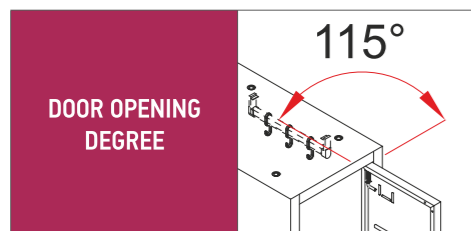

Monoblock



Powder Coated



Key Lock



Aeration





Cleaning



Warranty



STANDARD			
view			
catalogue code	WRZ/2.1830	WRZ/4.1860	WRZ/6.1890
production code	152M0601-00080	152M0601-00081	152M0601-00082
no of door	2	4	6
door type	standard	standard	standard
ventilation	louvered	louvered	louvered
height (mm)	1800	1800	1800
width (mm)	315	600	885
depth (mm)	500	500	500

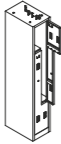
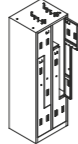
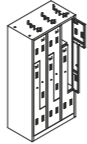

VERSION 1

view			
catalogue code	WRZ/2.1830.V1	WRZ/4.1860.V1	WRZ/6.1890.V1
production code	152M0601-00083	152M0601-00084	152M0601-00085
no of door	2	4	6
door type	standard	standard	standard
ventilation	square perforated	square perforated	square perforated
height (mm)	1800	1800	1800
width (mm)	315	600	885
depth (mm)	500	500	500

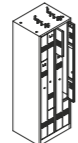
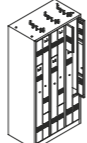
VERSION 2

view			
catalogue code	WRZ/2.1830.V2	WRZ/4.1860.V2	WRZ/6.1890.V2
production code	152M0601-00086	152M0601-00087	152M0601-00088
no of door	2	4	6
door type	swing	swing	swing
ventilation	louvered	louvered	louvered
height (mm)	1800	1800	1800
width (mm)	315	600	885
depth (mm)	500	500	500

VERSION 3

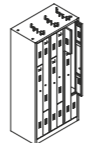
view			
catalogue code	WRZ/2.1830.V3	WRZ/4.1860.V3	WRZ/6.1890.V3
production code	152M0601-00089	152M0601-00090	152M0601-00091
no of door	2	4	6
door type	swing	swing	swing
ventilation	square perforated	square perforated	square perforated
height (mm)	1800	1800	1800
width (mm)	315	600	885
depth (mm)	500	500	500

VERSION 4

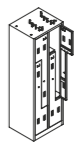
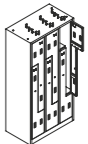
view			
catalogue code	WRZ/2.1830.V4	WRZ/4.1860.V4	WRZ/6.1890.V4
production code	152M0601-00092	152M0601-00093	152M0601-00094
no of door	2	4	6
door type	standard	standard	standard
ventilation	round perforated	round perforated	round perforated
height (mm)	1800	1800	1800
width (mm)	315	600	885
depth (mm)	500	500	500

VERSION 5

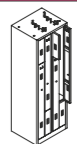
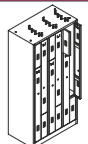
view			
catalogue code	WRZ/2.1830.V5	WRZ/4.1860.V5	WRZ/6.1890.V5
production code	152M0601-00095	152M0601-00096	152M0601-00097
no of door	2	4	6
door type	swing	swing	swing
ventilation	round perforated	round perforated	round perforated
height (mm)	1800	1800	1800
width (mm)	315	600	885
depth (mm)	500	500	500

FEATURES

- » Durable Welded Metal Construction
- » Electrostatic Powder Coating
- » Wall Mounting Holes on Rear Top
- » Coat Rail with Hook in Each Section
- » Reinforced Doors with Concealed Hinges and Anti-Noise Plastic Buffers
- » Stamped Label Holder on Doors
- » Louvered Doors for Air Circulation
- » 2.000 Differs Round Head Camlock with 2 Keys
- » Key Duplicate Support
- » Masterkey Support
- » Packaging: Nylon Bag + Corrugated Carton

OPTIONAL

- » Bolting Holes on Sides to Connect Cupboards [Fixing Kit is Not Included]
- » Perforated Door Types
- » Swing Door Models
- » Coin Lock
- » Keypad Combination Lock
- » Wheel Combination Lock
- » 2.000 Differs 3 Point Round Head Camlock with 2 Keys
- » Latchlock
- » Flush Latchlock
- » 3 Point Latchlock
- » 200 mm Sloping Roof [Fixing by Bolt]
- » 100 mm Base [Fixing by Bolt]
- » 100 mm Feet [Welded or Fixing by Bolt on Request]
- » 100 mm Framed Feet [Fixing by Bolt]
- » 400 mm Bench Models [Fixing by Bolt]

STANDARD COLORS FOR THIS RANGE

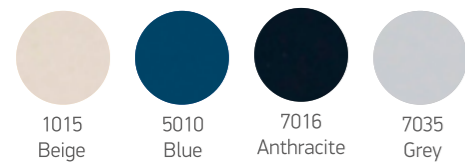

- » Non-standard colors are available with price difference (extra charge)
- » Production codes are referring items completely in color Grey 7035

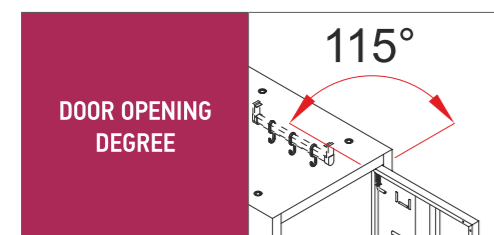

Monoblock



Powder Coated



Key Lock



Aeration



Cleaning



Warranty

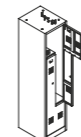
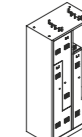
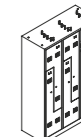

	STANDARD		
view			
catalogue code	WRZ/2.1840	WRZ/4.1880	WRZ/6.1812
production code	152M0601-00098	152M0601-00099	152M0601-00100
no of door	2	4	6
door type	standard	standard	standard
ventilation	louvered	louvered	louvered
height (mm)	1800	1800	1800
width (mm)	415	800	1185
depth (mm)	500	500	500



VERSION 1			
view			
catalogue code	WRZ/2.1840.V1	WRZ/4.1880.V1	WRZ/6.1812.V1
production code	152M0601-00101	152M0601-00102	152M0601-00103
no of door	2	4	6
door type	standard	standard	standard
ventilation	square perforated	square perforated	square perforated
height (mm)	1800	1800	1800
width (mm)	415	800	1185
depth (mm)	500	500	500

VERSION 2			
view			
catalogue code	WRZ/2.1840.V2	WRZ/4.1880.V2	WRZ/6.1812.V2
production code	152M0601-00104	152M0601-00105	152M0601-00106
no of door	2	4	6
door type	swing	swing	swing
ventilation	louvered	louvered	louvered
height (mm)	1800	1800	1800
width (mm)	415	800	1185
depth (mm)	500	500	500

VERSION 3			
view			
catalogue code	WRZ/2.1840.V3	WRZ/4.1880.V3	WRZ/6.1812.V3
production code	152M0601-00107	152M0601-00108	152M0601-00109
no of door	2	4	6
door type	swing	swing	swing
ventilation	square perforated	square perforated	square perforated
height (mm)	1800	1800	1800
width (mm)	415	800	1185
depth (mm)	500	500	500

VERSION 4			
view			
catalogue code	WRZ/2.1840.V4	WRZ/4.1880.V4	WRZ/6.1812.V4
production code	152M0601-00110	152M0601-00111	152M0601-00112
no of door	2	4	6
door type	standard	standard	standard
ventilation	round perforated	round perforated	round perforated
height (mm)	1800	1800	1800
width (mm)	415	800	1185
depth (mm)	500	500	500

VERSION 5			
view			
code	WRZ/2.1840.V5	WRZ/4.1880.V5	WRZ/6.1812.V5
	152M0601-00113	152M0601-00114	152M0601-00115
no of door	2	4	6
door type	swing	swing	swing
ventilation	round perforated	round perforated	round perforated
height (mm)	1800	1800	1800
width (mm)	415	800	1185
depth (mm)	500	500	500

FEATURES

- » Durable Welded Metal Construction
- » Electrostatic Powder Coating
- » Wall Mounting Holes on Rear Top
- » Under Top with Coat Rail and Hook in Each Section
- » Reinforced Doors with Concealed Hinges and Anti-Noise Plastic Buffers
- » Stamped Label Holder on Doors
- » Louvered Doors for Air Circulation
- » Bolting Holes on Sides to Connect Cupboards [Fixing Kit is Not Included]
- » 2.000 Differs Round Head Camlock with 2 Keys
- » Key Duplicate Support
- » Masterkey Support
- » Packaging: Nylon Bag + Corrugated Carton

OPTIONAL

- » Perforated Door Types
- » Coin Lock
- » Keypad Combination Lock
- » Wheel Combination Lock
- » 2.000 Differs 3 Point Round Head Camlock with 2 Keys
- » Latchlock
- » Flush Latchlock
- » 3 Point Latchlock
- » 200 mm Sloping Roof [Fixing by Bolt]
- » 100 mm Base [Fixing by Bolt]
- » 100 mm Feet [Welded or Fixing by Bolt on Request]
- » 100 mm Framed Feet [Fixing by Bolt]
- » 400 mm Bench Models [Fixing by Bolt]

STANDARD COLORS FOR THIS RANGE



- » Non-standard colors are available with price difference (extra charge)
- » Production codes are referring items completely in color Grey 7035

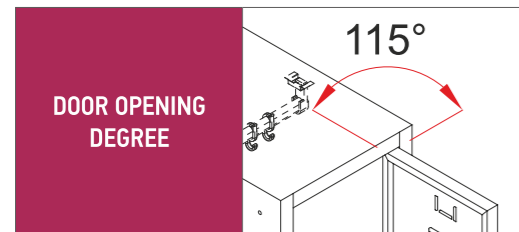

Monoblock

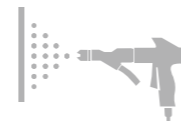

Powder Coated



Key Lock



Aeration



Cleaning



Warranty



STANDARD - 30 SERIES				
view				
catalogue code	WRK/1.1030	WRK/2.1060	WRK/3.1090	WRK/4.10117
production code	152M0601-00028	152M0601-00029	152M0601-00030	152M0601-00031
no of door	1	2	3	4
door type	right hung	right hung	right hung	right hung
ventilation	louvered	louvered	louvered	louvered
height (mm)	1025	1025	1025	1025
width (mm)	315	600	885	1170
depth (mm)	500	500	500	500

STANDARD - 40 SERIES				
view				
catalogue code	WRK/1.1040	WRK/2.1080	WRK/3.1012	WRK/4.10157
production code	152M0601-00032	152M0601-00033	152M0601-00034	152M0601-00035
no of door	1	2	3	4
door type	right hung	right hung	right hung	right hung
ventilation	louvered	louvered	louvered	louvered
height (mm)	1025	1025	1025	1025
width (mm)	415	800	1185	1570
depth (mm)	500	500	500	500

FEATURES

- » Durable Welded Metal Construction
- » Electrostatic Powder Coating
- » Wall Mounting Holes on Rear Top
- » Pull Down Coat Rail Lift and Bottom Shelf in Each Section
- » Reinforced Doors with Concealed Hinges and Anti-Noise Plastic Buffers
- » Stamped Label Holder on Doors
- » Louvered Doors for Air Circulation
- » 2.000 Differs Round Head Camlock with 2 Keys
- » Key Duplicate Support
- » Masterkey Support
- » Packaging: Nylon Bag + Corrugated Carton

OPTIONAL

- » Bolting Holes on Sides to Connect Cupboards [Fixing Kit is Not Included]
- » Latchlock
- » 100 mm Base [Fixing by Bolt]
- » 100 mm Feet [Welded or Fixing by Bolt on Request]
- » 100 mm Framed Feet [Fixing by Bolt]

STANDARD COLORS FOR THIS RANGE

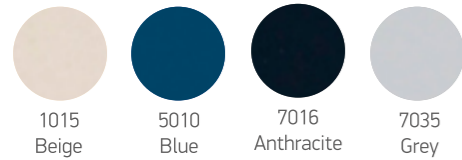

- » Non-standard colors are available with price difference (extra charge)
- » Production codes are referring items completely in color Grey 7035



Monoblock



Powder Coated



Key Lock



Aeration



Cleaning



Warranty



view			
catalogue code	WRDIS/1.1840	WRDIS/2.1880	WRDIS/3.1812
production code	152M0601-00133	152M0601-00134	152M0601-00135
no of door	1	2	3
door type	right hung	right hung	right hung
ventilation	louvered	louvered	louvered
height (mm)	1800	1800	1800
width (mm)	415	800	1185
depth (mm)	500	500	500

FEATURES

- » Durable Welded Metal Construction
- » Electrostatic Powder Coating
- » Wall Mounting Holes on Rear Top
- » Top Shelf with Coat Rail and Hook in Each Section
- » Reinforced Doors with Concealed Hinges and Anti-Noise Plastic Buffers
- » Door Switch with Automatic Cut Off when the Doors are Open
- » Fuse Box
- » Adjustable Thermostat
- » Additional 70 Degree Thermostat Switch
- » Drying Pipes for pair of Shoes/Boots
- » Top Ventilation Holes for Centralized Air Vacuum System
- » Easy Cupboard Connection (max 4) with Plug-in Electric Sockets
- » 2.000 Differs Round Head 3 Point Camlock with 2 Keys
- » Key Duplicate Support
- » Masterkey Support
- » Packaging: Nylon Bag + Corrugated Carton

STANDARD COLORS FOR THIS RANGE

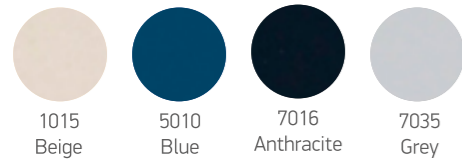

- » Non-standard colors are available with price difference (extra charge)
- » Production codes are referring items completely in color Grey 7035



Monoblock



Powder Coated



Key Lock



Aeration



Cleaning



Warranty

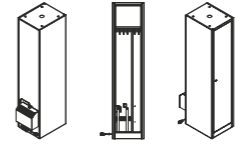
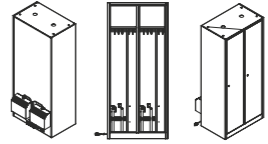
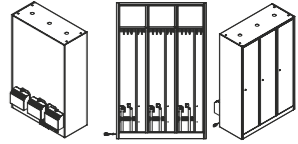

view			
catalogue code	HWRC-0001	HWRC-0002	HWRC-0003
production code	152M0601-00130	152M0601-00131	152M0601-00132
type	cupboard	cupboard	cupboard
no of door	1	2	3
door type	right hung	right hung	right hung
height (mm)	1800	1800	1800
width (mm)	415	800	1185
depth (mm)	500	500	500

* aeration equipments are not supplied

SLOPING ROOF



catalogue code	production code	height	width	depth
WRR.30	152M9909-00011	200	315	500
WRR.40	152M9909-00046	200	415	500
WRR.60	152M9909-00012	200	600	500
WRR.80	152M9909-00047	200	800	500
WRR.90	152M9909-00013	200	885	500
WRR.117	152M9909-00014	200	1170	500
WRR.120	152M9909-00048	200	1185	500

BASE



catalogue code	production code	height	width	depth
WBS.30	152M9909-00015	100	315	500
WBS.40	152M9909-00049	100	415	500
WBS.60	152M9909-00016	100	600	500
WBS.80	152M9909-00050	100	800	500
WBS.90	152M9909-00017	100	885	500
WBS.117	152M9909-00018	100	1170	500
WBS.120	152M9909-00051	100	1185	500

FRAMED FEET



catalogue code	production code	height	width	depth
WRF.30	152M9909-00019	100	315	500
WRF.40	152M9909-00052	100	415	500
WRF.60	152M9909-00020	100	600	500
WRF.80	152M9909-00053	100	800	500
WRF.90	152M9909-00021	100	885	500
WRF.117	152M9909-00022	100	1170	500
WRF.120	152M9909-00054	100	1185	500

FEET SET OF 4 - STANDARD



catalogue code	production code	height
FS4.H10/WM	152M9909-00023	100

FEET SET OF 4 - WITH LEVELLER



catalogue code	production code	height
FS4L.H10/WM	152M9909-00024	100

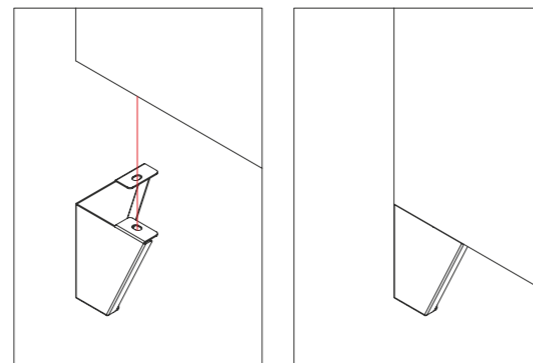

BENCH - STANDARD



catalogue code	production code	height	width	depth
WRB.30	152M9909-00025	400	315	800
WRB.40	152M9909-00055	400	415	800
WRB.60	152M9909-00026	400	600	800
WRB.80	152M9909-00056	400	800	800
WRB.90	152M9909-00027	400	885	800
WRB.117	152M9909-00028	400	1170	800
WRB.120	152M9909-00057	400	1185	800

BENCH WITH SHOE GRILL



catalogue code	production code	height	width	depth
WRB/SG.30	152M9909-00029	400	315	800
WRB/SG.40	152M9909-00058	400	415	800
WRB/SG.60	152M9909-00030	400	600	800
WRB/SG.80	152M9909-00059	400	800	800
WRB/SG.90	152M9909-00031	400	885	800
WRB/SG.117	152M9909-00032	400	1170	800
WRB/SG.120	152M9909-00060	400	1185	800

BENCH WITH PULL OUT SEAT



catalogue code	production code	height	width	depth
WRB/PO.30	152M9909-00033	400	315	800
WRB/PO.40	152M9909-00061	400	415	800
WRB/PO.60	152M9909-00034	400	600	800
WRB/PO.80	152M9909-00062	400	800	800
WRB/PO.90	152M9909-00035	400	885	800
WRB/PO.117	152M9909-00036	400	1170	800
WRB/PO.120	152M9909-00063	400	1185	800

FEATURES

- » Durable Welded Metal Construction
- » Electrostatic Powder Coating
- » Wall Mounting Holes on Rear Top
- » Coat Rail with Hook in Each Vertical Section
- » Horizontal and Vertical Doors with Concealed Hinges and Anti-Noise Plastic Buffers
- » Stamped Label Holder on Doors
- » Louvered Doors for Air Circulation
- » Paired Lock for Horizontal and Vertical Doors
- » 2.000 Differs Round Head Camlock with 2 Keys
- » Key Duplicate Support
- » Masterkey Support
- » Packaging: Nylon Bag + Corrugated Carton

OPTIONAL

- » Perforated Door Types
- » 200 mm Sloping Roof [Fixing by Bolt]
- » 100 mm Base [Fixing by Bolt]
- » 100 mm Feet [Welded or Fixing by Bolt on Request]
- » 100 mm Framed Feet [Fixing by Bolt]
- » 400 mm Bench Models [Fixing by Bolt]

STANDARD COLORS FOR THIS RANGE

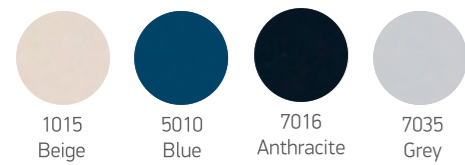

- » Non-standard colors are available with price difference (extra charge)
- » Production codes are referring items completely in color Grey 7035

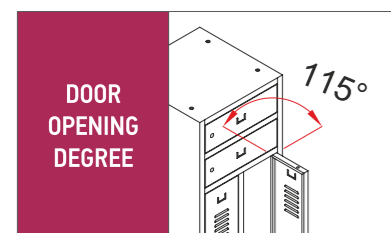
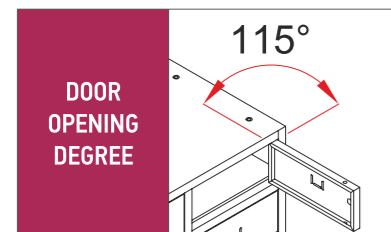

Monoblock



Powder Coated



Key Lock



Aeration



Cleaning



Warranty



view		
catalogue code	WRC/2H2V.1850	WRC/4H4V.1897
production code	152M0601-00128	152M0601-00129
no of door	2 horizontal + 2 vertical	4 horizontal + 4 vertical
door type	standard	standard
ventilation	louvered	louvered
height (mm)	1800	1800
width (mm)	500	970
depth (mm)	500	500

SLOPING ROOF



catalogue code	production code	height	width	depth
WRR.50	152M9909-00110	200	500	500
WRR.97	152M9909-00111	200	970	500

BASE



catalogue code	production code	height	width	depth
WBS.50	152M9909-00112	100	500	500
WBS.97	152M9909-00113	100	970	500

FRAMED FEET



catalogue code	production code	height	width	depth
WRF.50	152M9909-00114	100	500	500
WRF.97	152M9909-00115	100	970	500

FEET SET OF 4 - STANDARD



catalogue code	production code	height
FS4.H10/WM	152M9909-00023	100

FEET SET OF 4 - WITH LEVELLER



catalogue code	production code	height
FS4L.H10/WM	152M9909-00024	100

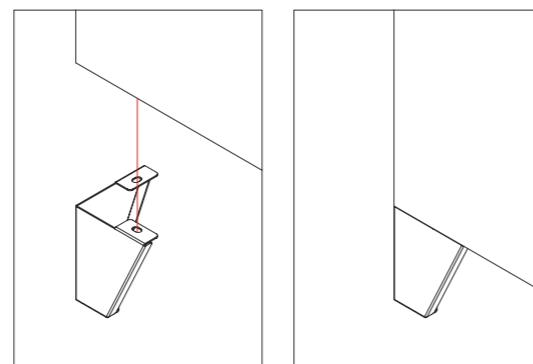

BENCH - STANDARD



catalogue code	production code	height	width	depth
WRB.50	152M9909-00116	400	500	800
WRB.97	152M9909-00117	400	970	800

BENCH WITH SHOE GRILL



catalogue code	production code	height	width	depth
WRB/SG.50	152M9909-00118	400	500	800
WRB/SG.97	152M9909-00119	400	970	800

BENCH WITH PULL OUT SEAT



catalogue code	production code	height	width	depth
WRB/PO.50	152M9909-00120	400	500	800
WRB/PO.97	152M9909-00121	400	970	800

FEATURES

- » Durable Welded Metal Construction
- » Electrostatic Powder Coating
- » Can be Multiple by Bolting Together Side by Side or on Each Other
- » Reinforced Doors with Concealed Hinges and Anti-Noise Plastic Buffers
- » Stamped Label Holder on Doors
- » Coat Rail with Hook in Each Section
- » 50 mm Base *
- » 2.000 Differs Round Head Camlock with 2 Keys
- » Key Duplicate Support
- » Masterkey Support
- » Packaging: Nylon Bag + Corrugated Carton

* Should be Ordered Separately as per Column

OPTIONAL

- » Perforated Door Types
- » Coin Lock
- » Keypad Combination Lock
- » Wheel Combination Lock
- » 2.000 Differs 3 Point Round Head Camlock with 2 Keys
- » Latchlock
- » Flush Latchlock
- » 3 Point Latchlock

STANDARD COLORS FOR THIS RANGE

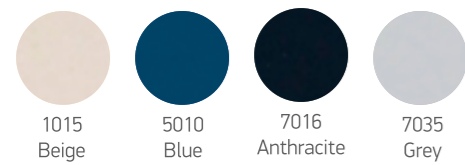

- » Non-standard colors are available with price difference (extra charge)
- » Production codes are referring items completely in color Grey 7035

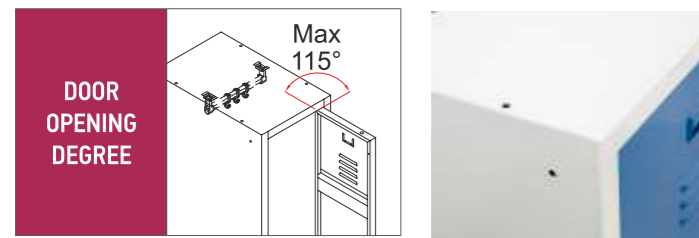

Monoblock



Powder Coated



Key Lock



Aeration



Cleaning



Warranty



view		
catalogue code	STWC/87.30.50	STWC/87.40.50
production code	152M0601-00078	152M0601-00079
no of door	1	1
door type	right hung	right hung
ventilation	louvered	louvered
height (mm)	875	875
width (mm)	315	415
depth (mm)	500	500

view		
catalogue code	BS/STWC/5.30.50	BS/STWC/5.40.50
production code	152M9909-00064	152M9909-00065
item	base	base
height (mm)	50	50
width (mm)	315	415
depth (mm)	500	500

WALL MOUNT RACKS

FEATURES

- » Metal Frame
- » Varnished Hornbeam Slats
- » Wall Fixing Bracket [Fixing Kit is Not Included]
- » Packaging: Flatpack in Corrugated Carton

OPTIONAL

- » Plastic Slat

WALL MOUNT BENCHES

FEATURES

- » Metal Frame
- » Varnished Hornbeam Slats
- » Wall Fixing Bracket [Fixing Kit is Not Included]
- » Legs with Floor Fixing Part [Fixing Kit is Not Included]
- » Packaging: Flatpack in Corrugated Carton

OPTIONAL

- » Plastic Slat

SEPARATE BENCHES

FEATURES

- » Metal Frame
- » Varnished Hornbeam Slats
- » Legs with Floor Fixing Part [Fixing Kit is Not Included]
- » Packaging: Flatpack in Corrugated Carton

OPTIONAL

- » Plastic Slat
- » Shoe Grill

STACKABLE BENCHES

FEATURES

- » Metal Frame
- » Varnished Hornbeam Slats
- » Packaging: Stacked on Pallet

OPTIONAL

- » Plastic Slat

STANDARD METAL COLORS FOR THIS RANGE

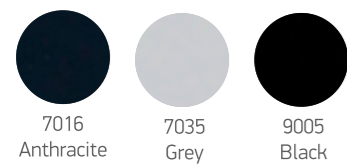

STANDARD PLASTIC COLORS FOR THIS RANGE



- » Non-standard colors are available with price difference (extra charge)
- » Production codes are referring items completely in color Grey 7035



Flatpack



Powder Coated



Cleaning



Warranty

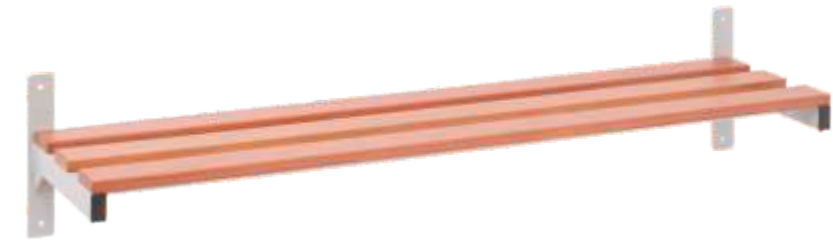

WALL MOUNT RACK				
catalogue code	production code	height	width	depth
WMR/WS.100	152M9702-00001	250	1000	300
WMR/WS.120	152M9702-00002	250	1200	300
WMR/WS.140	152M9702-00003	250	1400	300



WALL MOUNT BENCH				
catalogue code	production code	height	width	depth
WMB.4010030	152M0401-00001	400	1000	300
WMB.4012030	152M0401-00002	400	1200	300
WMB.4014030	152M0401-00003	400	1400	300

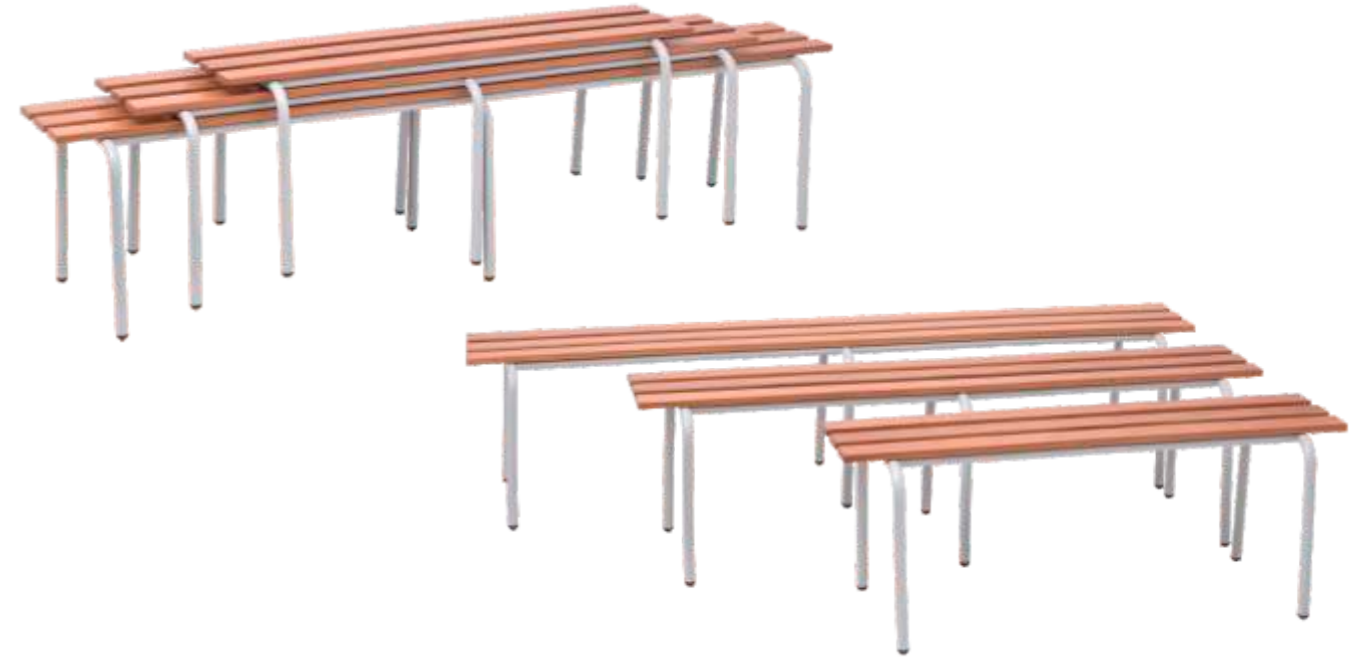

SEPARATE BENCH



SRB.40	152M0401-00004	400	400	400
SRB.60	152M0401-00005	400	600	400
SRB.80	152M0401-00006	400	800	400
SRB.90	152M0401-00007	400	900	400
SRB.100	152M0401-00008	400	1000	400
SRB.120	152M0401-00009	400	1200	400
SRB.150	152M0401-00010	400	1500	400
SRB.160	152M0401-00011	400	1600	400
SRB.200	152M0401-00012	400	2000	400
SRB.200	152M0401-00012	400	2000	400



STACKABLE BENCH



catalogue code	production code	height	width	depth
STB.120	152M0401-00018	450	1200	430
STB.160	152M0401-00019	450	1600	430
STB.200	152M0401-00020	450	2000	430

SEPARATE BENCH WITH BACK REST



catalogue code	production code	height	width	depth
SRB/R.100	152M0401-00013	400-900(th)	1000	400
SRB/R.120	152M0401-00014	400-900(th)	1200	400
SRB/R.150	152M0401-00015	400-900(th)	1500	400
SRB/R.160	152M0401-00016	400-900(th)	1600	400
SRB/R.200	152M0401-00017	400-900(th)	2000	400

DETAIL



FLOOR FIXING

OPTIONAL



PLASTIC SLAT

FEATURES

- » Metal Frame
- » Varnished Hornbeam Slats
- » Single and Double Sided Bench Units
- » Legs with Floor Fixing Part [Fixing Kit is Not Included]
- » Packaging: Flatpack in Corrugated Carton

OPTIONAL

- » Plastic Slat

STANDARD METAL COLORS FOR THIS RANGE

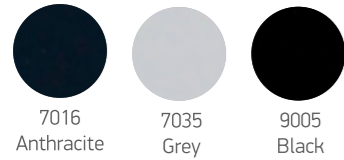

STANDARD PLASTIC COLORS FOR THIS RANGE



- » Non-standard colors are available with price difference (extra charge)
- » Production codes are referring items completely in color Grey 7035



Flatpack



Powder Coated



Cleaning



Warranty



SINGLE SIDED BENCH UNITS

view						
catalogue code	production code	model	no of hooks	height	width	depth
SBU/BG.120	152M0401-00021	only bottom grill	4	400(sh)-1825(th)	1200	400
SBU/BG.160	152M0401-00022	only bottom grill	6	400(sh)-1825(th)	1600	400
SBU/BG.200	152M0401-00023	only bottom grill	8	400(sh)-1825(th)	2000	400
SBU/TBG.120	152M0401-00024	top & bottom grill	4	400(sh)-1890(th)	1200	400
SBU/TBG.160	152M0401-00025	top & bottom grill	6	400(sh)-1890(th)	1600	400
SBU/TBG.200	152M0401-00026	top & bottom grill	8	400(sh)-1890(th)	2000	400

DOUBLE SIDED BENCH UNITS

view						
catalogue code	production code	model	no of hooks	height	width	depth
DBU/BG.120	152M0401-00027	only bottom grill	4+4	400(sh)-1825(th)	1200	770
DBU/BG.160	152M0401-00028	only bottom grill	6+6	400(sh)-1825(th)	1600	770
DBU/BG.200	152M0401-00029	only bottom grill	8+8	400(sh)-1825(th)	2000	770
DBU/TBG.120	152M0401-00030	top & bottom grill	4+4	400(sh)-1890(th)	1200	770
DBU/TBG.160	152M0401-00031	top & bottom grill	6+6	400(sh)-1890(th)	1600	770
DBU/TBG.200	152M0401-00032	top & bottom grill	8+8	400(sh)-1890(th)	2000	770

FEATURES

- » Durable Welded Metal Construction
- » Electrostatic Powder Coating
- » Wall Mounting Holes on Rear Top
- » Upper Shelf for Helmet
- » Coat Rail with Hook in Each Section
- » Reinforced Doors with Concealed Hinges and Anti-Noise Plastic Buffers
- » Louvered Doors for Air Circulation
- » Envelope Case and 2 Hooks on Doors
- » 2.000 Differs Round Head Camlock with 2 Keys
- » Key Duplicate Support
- » Masterkey Support
- » Packaging: Nylon Bag + Corrugated Carton

OPTIONAL

- » Bolting Holes on Sides to Connect Cupboards [Fixing Kit is Not Included]
- » Wheel Combination Lock
- » 2.000 Differs 3 Point Round Head Camlock with 2 Keys
- » Latchlock
- » Flush Latchlock
- » 3 Point Latchlock
- » Perforated Bottom
- » 200 mm Sloping Roof [Fixing by Bolt]
- » 100 mm Base [Fixing by Bolt]
- » 100 mm Feet [Welded or Fixing by Bolt on Request]
- » 100 mm Framed Feet [Fixing by Bolt]

STANDARD COLORS FOR THIS RANGE

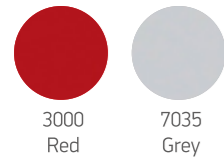

- » Non-standard colors are available with price difference (extra charge)
- » Production codes are referring items completely in color Grey 7035

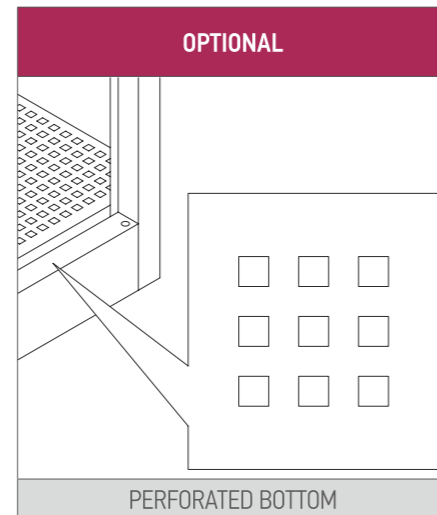

Monoblock



Powder Coated



Key Lock



Aeration



Cleaning



Warranty



STANDARD MODEL			
view			
catalogue code	FRM.1	FRM.2	FRM.3
production code	152M0603-00001	152M0603-00002	152M0603-00003
no of door	1	2	3
door type	right hand	right hand	right hand
ventilation	louvered	louvered	louvered
height (mm)	1950	1950	1950
width (mm)	500	970	1440
depth (mm)	550	550	550

SLOPING ROOF

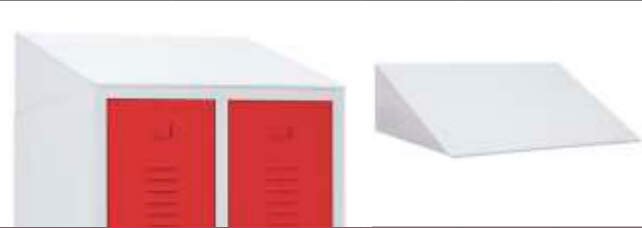

catalogue code	production code	height	width	depth
SR/20.50.55	152M9909-00122	200	500	550
SR/20.97.55	152M9909-00123	200	970	550
SR/20.144.55	152M9909-00124	200	1440	550

BASE



catalogue code	production code	height	width	depth
FBS/10.50.55	152M9909-00125	100	500	550
FBS/10.97.55	152M9909-00126	100	970	550
FBS/10.144.55	152M9909-00127	100	1440	550

FRAMED FEET



catalogue code	production code	height	width	depth
FRF/10.50.55	152M9909-00128	100	500	550
FRF/10.97.55	152M9909-00129	100	970	550
FRF/10.144.55	152M9909-00130	100	1440	550

FEET SET OF 4 - STANDARD



catalogue code	production code	height
FS4.H10/WM	152M9909-00023	100

FEET SET OF 4 - WITH LEVELLER



catalogue code	production code	height
FS4L.H10/WM	152M9909-00024	100

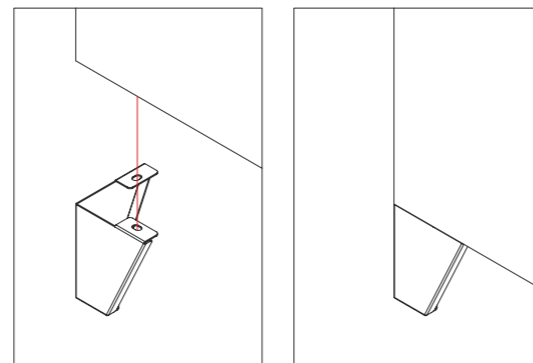

BENCH - STANDARD



catalogue code	production code	height	width	depth
FRB.50	152M9909-00131	400	500	850
FRB.97	152M9909-00132	400	970	850
FRB.144	152M9909-00133	400	1440	850

BENCH WITH SHOE GRILL



catalogue code	production code	height	width	depth
FRB/SG.50	152M9909-00134	400	500	850
FRB/SG.97	152M9909-00135	400	970	850
FRB/SG.144	152M9909-00136	400	1440	850

BENCH WITH PULL OUT SEAT



catalogue code	production code	height	width	depth
FRB/PO.50	152M9909-00137	400	500	850
FRB/PO.97	152M9909-00138	400	970	850
FRB/PO.144	152M9909-00139	400	1440	850

FEATURES

- » Durable Welded Metal Construction
- » Electrostatic Powder Coating
- » Wall Mounting Holes on Rear Top
- » Bolting Holes on Sides to Connect Cupboards and Vestuary Sets [Fixing Kit is Not Included]
- » Top & Bottom Compartments
- » Open & Small Top Door & Big Bottom Door Models
- » Coat Rail with Hook & Welded Side Hook in Big Bottom Compartment
- » Helmet Holder for Top
- » Reinforced Doors with Concealed Hinges and Anti-Noise Plastic Buffers
- » Envelope Hole on Small Top Door
- » Louvered Ventilation on Big Bottom Doors for Air Circulation
- » 2.000 Differs Round Head Camlock with 2 Keys
- » Key Duplicate Support
- » Masterkey Support
- » Packaging: Nylon Bag + Corrugated Carton

OPTIONAL

- » Vestuary Sets
- » Wheel Combination Lock
- » 2.000 Differs 3 Point Round Head Camlock with 2 Keys
- » Latchlock
- » Flush Latchlock
- » 3 Point Latchlock
- » 200 mm Sloping Roof [Fixing by Bolt]
- » 100 mm Base [Fixing by Bolt]
- » 100 mm Feet [Welded or Fixing by Bolt on Request]
- » 100 mm Framed Feet [Fixing by Bolt]



STANDARD COLORS FOR THIS RANGE

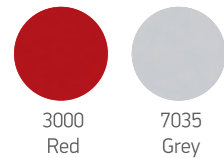

- » Non-standard colors are available with price difference (extra charge)
- » Production codes are referring items completely in color Grey 7035

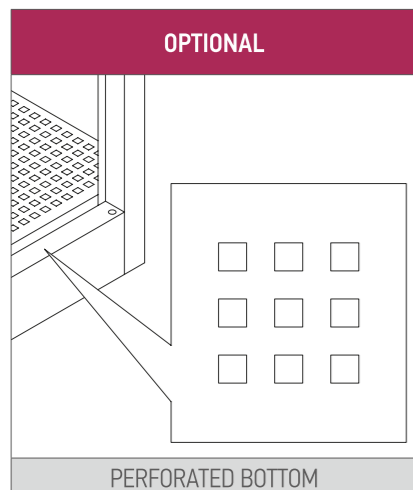
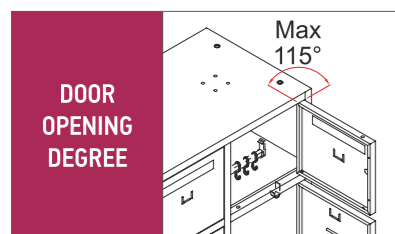

Monoblock

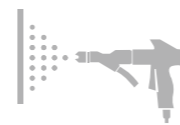

Powder Coated



Key Lock



Aeration





Cleaning



Warranty



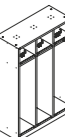

OPEN MODEL - NO DOOR			
view			
catalogue code	FM0/1.1840	FM0/2.1880	FM0/3.1812
production code	152M0603-00004	152M0603-00005	152M0603-00006
no of door	n/a	n/a	n/a
door type	right hand	right hand	right hand
ventilation	n/a	n/a	n/a
height (mm)	1800	1800	1800
width (mm)	415	800	1185
depth (mm)	500	500	500

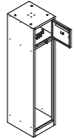
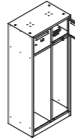
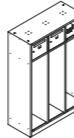

OPEN MODEL - SMALL DOOR

view			
catalogue code	FM0/SD/1.1840	FM0/SD/2.1880	FM0/SD/3.1812
production code	152M0603-00007	152M0603-00008	152M0603-00009
no of door	1S	2S	3S
door type	right hand	right hand	right hand
ventilation	n/a	n/a	n/a
height (mm)	1800	1800	1800
width (mm)	415	800	1185
depth (mm)	500	500	500

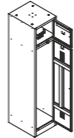
OPEN MODEL - SMALL DOOR + BIG DOOR

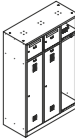
view			
catalogue code	FM0/SBD/1.1840	FM0/SBD/2.1880	FM0/SBD/3.1812
production code	152M0603-00010	152M0603-00011	152M0603-00012
no of door	1S+1B	2S+2B	3S+3B
door type	right hand	right hand	right hand
ventilation	louvered	louvered	louvered
height (mm)	1800	1800	1800
width (mm)	415	800	1185
depth (mm)	500	500	500

SLOPING ROOF



catalogue code	production code	height	width	depth
WRR.40	152M9909-00046	200	415	500
WRR.80	152M9909-00047	200	800	500
WRR.120	152M9909-00048	200	1185	500

BASE



catalogue code	production code	height	width	depth
WBS.40	152M9909-00049	100	415	500
WBS.80	152M9909-00050	100	800	500
WBS.120	152M9909-00051	100	1185	500

FRAMED FEET



catalogue code	production code	height	width	depth
WRF.40	152M9909-00052	100	415	500
WRF.80	152M9909-00053	100	800	500
WRF.120	152M9909-00054	100	1185	500

FEET SET OF 4 - STANDARD



catalogue code	production code	height
FS4.H10/WM	152M9909-00023	100

FEET SET OF 4 - WITH LEVELLER



catalogue code	production code	height
FS4L.H10/WM	152M9909-00024	100

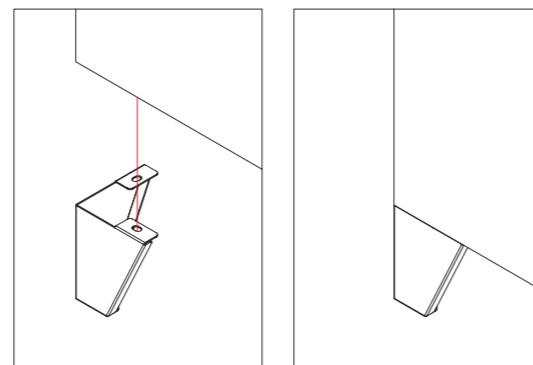

BENCH - STANDARD



catalogue code	production code	height	width	depth
WRB.40	152M9909-00055	400	415	800
WRB.80	152M9909-00056	400	800	800
WRB.120	152M9909-00057	400	1185	800

BENCH WITH SHOE GRILL



catalogue code	production code	height	width	depth
WRB/SG.40	152M9909-00058	400	415	800
WRB/SG.80	152M9909-00059	400	800	800
WRB/SG.120	152M9909-00060	400	1185	800

BENCH WITH PULL OUT SEAT



catalogue code	production code	height	width	depth
WRB/PO.40	152M9909-00061	400	415	800
WRB/PO.80	152M9909-00062	400	800	800
WRB/PO.120	152M9909-00063	400	1185	800

HELMET HOLDER



catalogue code	production code	height	dome diameter
HHO/FMO	152M9909-00140	300	ø 100

VESTIARY SHELF SET

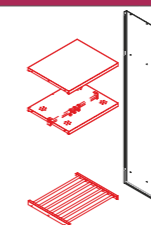

catalogue code	production code	width	depth
VST.6050	152M9909-00141	600	500
VST.8050	152M9909-00142	800	500
VST.10050	152M9909-00143	1000	500
VST.12050	152M9909-00144	1200	500

VESTIARY SIDE

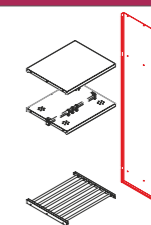

catalogue code	production code	height	depth
VSS.18050	152M9909-00145	1800	500

FEATURES

- » Heavy Duty Welded Metal Construction
- » Electrostatic Powder Coating
- » Wall Mounting Holes on Rear Top
- » Handgun Case with Lock on Top Shelf
- » Coat Rail with Hook in Each Section
- » Small Shelves for Storage of Various Police Tools
- » Mirror & Sunglasses-Handcuffs Cases & Baton Holder on Doors
- » Round Perforated Doors for Air Circulation
- » Anti-Noise Plastic Buffers on Doors
- » Stamped Label Holder on Doors
- » 1.000 Differs 3 Point Flush Handle Lock with 2 Keys
- » Key Duplicate Support
- » Masterkey Support
- » Packaging: Nylon Bag + Corrugated Carton

OPTIONAL

- » Bolting Holes on Sides to Connect Cupboards [Fixing Kit is Not Included]
- » 200 mm Sloping Roof [Fixing by Bolt]
- » 100 mm Base [Fixing by Bolt]
- » 100 mm Feet [Welded or Fixing by Bolt on Request]
- » 100 mm Framed Feet [Fixing by Bolt]
- » 400 mm Bench Models [Fixing by Bolt]

STANDARD COLORS FOR THIS RANGE

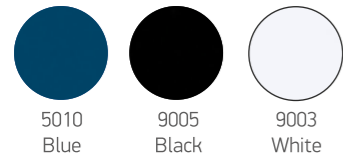

- » Non-standard colors are available with price difference (extra charge)
- » Production codes are referring items in color White 9003 with Blue 5010 doors

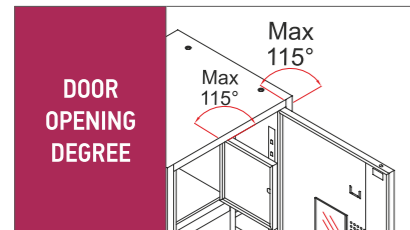

Monoblock



Powder Coated



Key Lock



Aeration



Cleaning



Warranty



view		
catalogue code	PLC.1	PLC.2
production code	152M0605-00001	152M0605-00002
no of door	1	2
door type	right hand	right hand
ventilation	round perforated	round perforated
height (mm)	1800	1800
width (mm)	600	1170
depth (mm)	550	550

SLOPING ROOF



catalogue code	production code	height	width	depth
SR/20.60.55	152M9909-00146	200	600	550
SR/20.117.55	152M9909-00147	200	1170	550

BASE



catalogue code	production code	height	width	depth
PBS/10.60.55	152M9909-00148	100	600	550
PBS/10.117.55	152M9909-00149	100	1170	550

FRAMED FEET



catalogue code	production code	height	width	depth
FRF/10.60.55	152M9909-00150	100	600	550
FRF/10.117.55	152M9909-00151	100	1170	550

FEET SET OF 4 - STANDARD



catalogue code	production code	height
FS4.H10/WM	152M9909-00023	100

FEET SET OF 4 - WITH LEVELLER



catalogue code	production code	height
FS4L.H10/WM	152M9909-00024	100

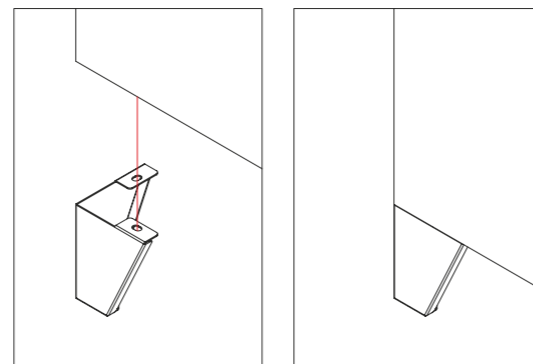

BENCH - STANDARD



catalogue code	production code	height	width	depth
PLB.60	152M9909-00152	400	600	850
PLB.117	152M9909-00153	400	1170	850

BENCH WITH SHOE GRILL



catalogue code	production code	height	width	depth
PLB/SG.60	152M9909-00154	400	600	850
PLB/SG.117	152M9909-00155	400	1170	850

BENCH WITH PULL OUT SEAT



catalogue code	production code	height	width	depth
PLB/PO.60	152M9909-00156	400	600	850
PLB/PO.117	152M9909-00157	400	1170	850

FEATURES

- » Durable Welded Metal Construction
- » Electrostatic Powder Coating
- » Can be Multiple by Bolting Together Side by Side or on Each Other
- » Reinforced Doors with Semi-Concealed Hinges and Anti-Noise Plastic Buffers
- » Stamped Label Holder on Doors
- » 80 mm Base *
- » 2.000 Differs Round Head Camlock with 2 Keys
- » Key Duplicate Support
- » Masterkey Support
- » Packaging: Nylon Bag + Corrugated Carton
- * **Should be Ordered Separately as per Column**

STANDARD COLORS FOR THIS RANGE

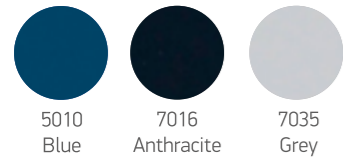

- » Non-standard colors are available with price difference (extra charge)
- » Production codes are referring items completely in color Grey 7035

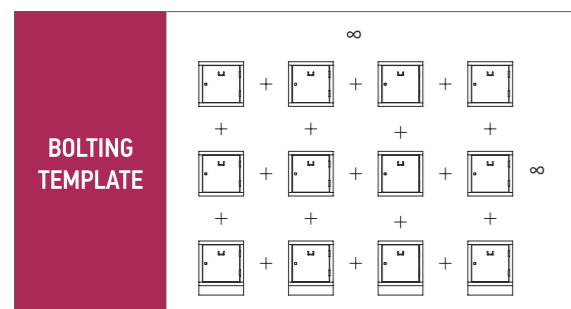
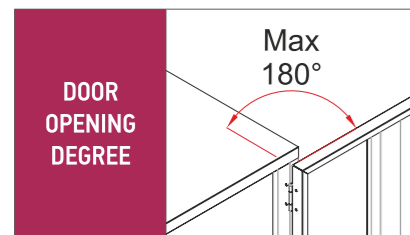

OPTIONAL

- » Coin Lock
- » Keypad Combination Lock
- » Wheel Combination Lock
- » Latchlock
- » Flush Latchlock



view						
catalogue code	CBL.30	CBL.38	CBL.45	BS/CBL.30	BS/CBL.38	BS/CBL.45
production code	152M0602-00001	152M0602-00002	152M0602-00003	152M9909-00158	152M9909-00159	152M9909-00160
item	cube locker	cube locker	cube locker	base	base	base
height (mm)	305	380	450	80	80	80
width (mm)	305	380	450	305	380	450
depth (mm)	305	380	450	295	370	440

FEATURES

- » Durable Welded Metal Construction
- » Electrostatic Powder Coating
- » Wall Mounting Holes on Rear Top
- » 3/4/5 Doors Models
- » Reinforced Doors with Anti-Noise Plastic Buffers
- » Concealed Full Length Bar Hinge
- » Stamped Label Holder on Doors
- » 2.000 Differs Round Head Camlock with 2 Keys
- » Key Duplicate Support
- » Masterkey Support
- » Packaging: Nylon Bag + Corrugated Carton

OPTIONAL

- » Bolting Holes on Sides to Connect Cupboards [Fixing Kit is Not Included]
- » Envelope Hole on Doors
- » Coin Lock
- » Keypad Combination Lock
- » Wheel Combination Lock
- » Latchlock
- » Flush Latchlock
- » 200 mm Sloping Roof [Fixing by Bolt]
- » 100 mm Base [Fixing by Bolt]
- » 100 mm Feet [Welded or Fixing by Bolt on Request]
- » 100 mm Framed Feet [Fixing by Bolt]

STANDARD COLORS FOR THIS RANGE

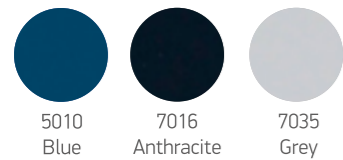

- » Non-standard colors are available with price difference (extra charge)
- » Production codes are referring items completely in color Grey 7035

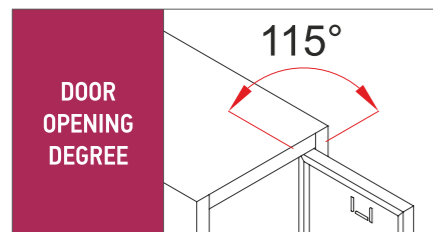



1/3 SERIES				
view				
catalogue code	MCL.3(1.3).30	MCL.6(2.3).30	MCL.9(3.3).30	MCL.12(4.3).30
production code	152M0602-00004	152M0602-00005	152M0602-00006	152M0602-00007
no of door	3	6	9	12
height (mm)	1800	1800	1800	1800
width (mm)	315	600	885	1170
depth (mm)	500	500	500	500

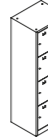
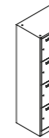
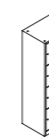

1/4 SERIES

view				
catalogue code	MCL.4(1.4).30	MCL.8(2.4).30	MCL.12(3.4).30	MCL.16(4.4).30
production code	152M0602-00008	152M0602-00009	152M0602-00010	152M0602-00011
no of door	4	8	12	16
height (mm)	1800	1800	1800	1800
width (mm)	315	600	885	1170
depth (mm)	500	500	500	500

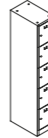
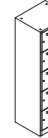
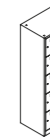
1/5 SERIES

view				
catalogue code	MCL.5(1.5).30	MCL.10(2.5).30	MCL.15(3.5).30	MCL.20(4.5).30
production code	152M0602-00012	152M0602-00013	152M0602-00014	152M0602-00015
no of door	5	10	15	20
height (mm)	1800	1800	1800	1800
width (mm)	315	600	885	1170
depth (mm)	500	500	500	500

FEATURES

- » Durable Welded Metal Construction
- » Electrostatic Powder Coating
- » Wall Mounting Holes on Rear Top
- » 3/4/5 Doors Models
- » Reinforced Doors with Anti-Noise Plastic Buffers
- » Concealed Full Length Bar Hinge
- » Stamped Label Holder on Doors
- » 2.000 Differs Round Head Camlock with 2 Keys
- » Key Duplicate Support
- » Masterkey Support
- » Packaging: Nylon Bag + Corrugated Carton

STANDARD COLORS FOR THIS RANGE

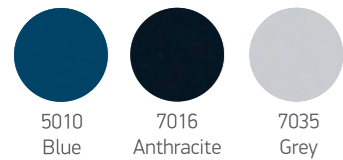

- » Non-standard colors are available with price difference (extra charge)
- » Production codes are referring items completely in color Grey 7035

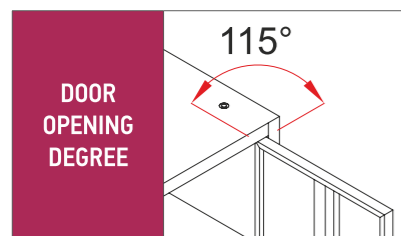

OPTIONAL

- » Bolting Holes on Sides to Connect Cupboards [Fixing Kit is Not Included]
- » Envelope Hole on Doors
- » Coin Lock
- » Keypad Combination Lock
- » Wheel Combination Lock
- » Latchlock
- » Flush Latchlock
- » 200 mm Sloping Roof [Fixing by Bolt]
- » 100 mm Base [Fixing by Bolt]
- » 100 mm Feet [Welded or Fixing by Bolt on Request]
- » 100 mm Framed Feet [Fixing by Bolt]



Monoblock



Powder Coated



Key Lock



Cleaning



Warranty

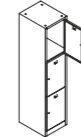
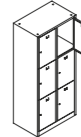
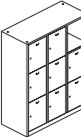

1/3 SERIES			
view			
catalogue code	MCL.3(1.3).40	MCL.6(2.3).40	MCL.9(3.3).40
production code	152M0602-00016	152M0602-00017	152M0602-00018
no of door	3	6	9
height (mm)	1800	1800	1800
width (mm)	415	800	1185
depth (mm)	500	500	500

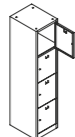
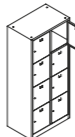
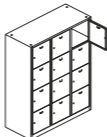

1/4 SERIES

view			
catalogue code	MCL.4(1.4).40	MCL.8(2.4).40	MCL.12(3.4).40
production code	152M0602-00019	152M0602-00020	152M0602-00021
no of door	4	8	12
height (mm)	1800	1800	1800
width (mm)	415	800	1185
depth (mm)	500	500	500

1/5 SERIES

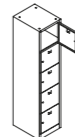
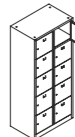
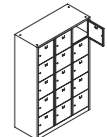
view			
catalogue code	MCL.5(1.5).40	MCL.10(2.5).40	MCL.15(3.5).40
production code	152M0602-00022	152M0602-00023	152M0602-00024
no of door	5	10	15
height (mm)	1800	1800	1800
width (mm)	415	800	1185
depth (mm)	500	500	500

SLOPING ROOF



catalogue code	production code	height	width	depth
WRR.30	152M9909-00011	200	315	500
WRR.40	152M9909-00046	200	415	500
WRR.60	152M9909-00012	200	600	500
WRR.80	152M9909-00047	200	800	500
WRR.90	152M9909-00013	200	885	500
WRR.117	152M9909-00014	200	1170	500
WRR.120	152M9909-00048	200	1185	500

BASE



catalogue code	production code	height	width	depth
WBS.30	152M9909-00015	100	315	500
WBS.40	152M9909-00049	100	415	500
WBS.60	152M9909-00016	100	600	500
WBS.80	152M9909-00050	100	800	500
WBS.90	152M9909-00017	100	885	500
WBS.117	152M9909-00018	100	1170	500
WBS.120	152M9909-00051	100	1185	500

FRAMED FEET



catalogue code	production code	height	width	depth
WRF.30	152M9909-00019	100	315	500
WRF.40	152M9909-00052	100	415	500
WRF.60	152M9909-00020	100	600	500
WRF.80	152M9909-00053	100	800	500
WRF.90	152M9909-00021	100	885	500
WRF.117	152M9909-00022	100	1170	500
WRF.120	152M9909-00054	100	1185	500

FEET SET OF 4 - STANDARD



catalogue code	production code	height
FS4.H10/WM	152M9909-00023	100

FEET SET OF 4 - WITH LEVELLER



catalogue code	production code	height
FS4L.H10/WM	152M9909-00024	100

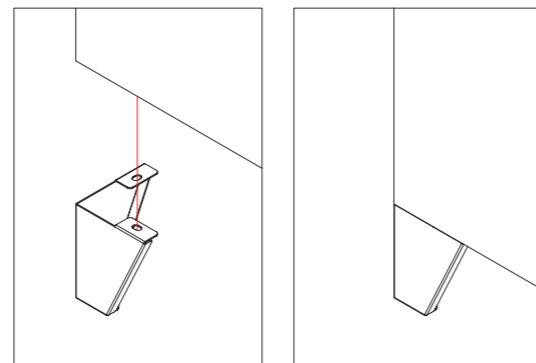

BENCH - STANDARD



catalogue code	production code	height	width	depth
WRB.30	152M9909-00025	400	315	800
WRB.40	152M9909-00055	400	415	800
WRB.60	152M9909-00026	400	600	800
WRB.80	152M9909-00056	400	800	800
WRB.90	152M9909-00027	400	885	800
WRB.117	152M9909-00028	400	1170	800
WRB.120	152M9909-00057	400	1185	800

BENCH WITH SHOE GRILL



catalogue code	production code	height	width	depth
WRB/SG.30	152M9909-00029	400	315	800
WRB/SG.40	152M9909-00058	400	415	800
WRB/SG.60	152M9909-00030	400	600	800
WRB/SG.80	152M9909-00059	400	800	800
WRB/SG.90	152M9909-00031	400	885	800
WRB/SG.117	152M9909-00032	400	1170	800
WRB/SG.120	152M9909-00060	400	1185	800

BENCH WITH PULL OUT SEAT



catalogue code	production code	height	width	depth
WRB/PO.30	152M9909-00033	400	315	800
WRB/PO.40	152M9909-00061	400	415	800
WRB/PO.60	152M9909-00034	400	600	800
WRB/PO.80	152M9909-00062	400	800	800
WRB/PO.90	152M9909-00035	400	885	800
WRB/PO.117	152M9909-00036	400	1170	800
WRB/PO.120	152M9909-00063	400	1185	800

FEATURES

- » Durable Welded Metal Construction
- » Electrostatic Powder Coating
- » Wall Mounting Holes on Rear Top
- » 3/4/5 Doors Models
- » Reinforced Doors with Anti-Noise Plastic Buffers
- » Concealed Full Length Bar Hinge
- » Stamped Label Holder on Doors
- » 2.000 Differs Round Head Camlock with 2 Keys
- » Key Duplicate Support
- » Masterkey Support
- » Packaging: Nylon Bag + Corrugated Carton

OPTIONAL

- » Bolting Holes on Sides to Connect Cupboards [Fixing Kit is Not Included]
- » Envelope Hole on Doors
- » Coin Lock
- » Keypad Combination Lock
- » Wheel Combination Lock
- » Latchlock
- » Flush Latchlock
- » 200 mm Sloping Roof [Fixing by Bolt]
- » 100 mm Base [Fixing by Bolt]
- » 100 mm Feet [Welded or Fixing by Bolt on Request]
- » 100 mm Framed Feet [Fixing by Bolt]

STANDARD COLORS FOR THIS RANGE

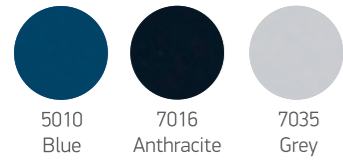

- » Non-standard colors are available with price difference (extra charge)
- » Production codes are referring items completely in color Grey 7035



Warranty

1/3 SERIES

view			
catalogue code	SHC.3(1.3).40	SHC.6(2.3).40	SHC.9(3.3).40
production code	152M0604-00001	152M0604-00002	152M0604-00003
door(s)	3	6	9
height (mm)	1900	1900	1900
width (mm)	415	800	1185
depth (mm)	450	450	450

1/4 SERIES

view			
catalogue code	SHC.4(1.4).40	SHC.8(2.4).40	SHC.12(3.4).40
production code	152M0604-00004	152M0604-00005	152M0604-00006
door(s)	4	8	12
height (mm)	1900	1900	1900
width (mm)	415	800	1185
depth (mm)	450	450	450

1/5 SERIES

view			
catalogue code	SHC.5(1.5).40	SHC.10(2.5).40	SHC.15(3.5).40
production code	152M0604-00007	152M0604-00008	152M0604-00009
door(s)	5	10	15
height (mm)	1900	1900	1900
width (mm)	415	800	1185
depth (mm)	450	450	450

SLOPING ROOF



catalogue code	production code	height	width	depth
SHR.41	152M9909-00161	200	415	450
SHR.80	152M9909-00162	200	800	450
SHR.119	152M9909-00163	200	1185	450

BASE



catalogue code	production code	height	width	depth
SBS.41	152M9909-00164	100	415	450
SBS.80	152M9909-00165	100	800	450
SBS.119	152M9909-00166	100	1185	450

FRAMED FEET



catalogue code	production code	height	width	depth
SHF.41	152M9909-00167	100	415	450
SHF.80	152M9909-00168	100	800	450
SHF.119	152M9909-00169	100	1185	450

FEET SET OF 4 - STANDARD



catalogue code	production code	height
FS4.H10/WM	152M9909-00023	100

FEET SET OF 4 - WITH LEVELLER



catalogue code	production code	height
FS4L.H10/WM	152M9909-00024	100

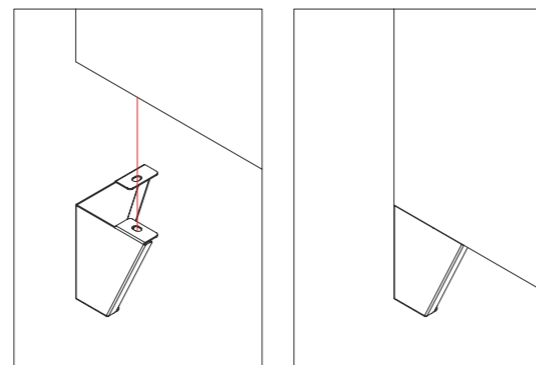

BENCH - STANDARD



catalogue code	production code	height	width	depth
SHB.41	152M9909-00170	400	415	750
SHB.80	152M9909-00171	400	800	750
SHB.119	152M9909-00172	400	1185	750

BENCH WITH SHOE GRILL



catalogue code	production code	height	width	depth
SHB/SG.41	152M9909-00173	400	415	750
SHB/SG.80	152M9909-00174	400	800	750
SHB/SG.119	152M9909-00175	400	1185	750

BENCH WITH PULL OUT SEAT



catalogue code	production code	height	width	depth
SHB/PO.41	152M9909-00176	400	415	750
SHB/PO.80	152M9909-00177	400	800	750
SHB/PO.119	152M9909-00178	400	1185	750

FEATURES

- » Durable Welded Metal Construction
- » Electrostatic Powder Coating
- » Combination of Lockers & Vestuary Set & Side Panels
- » 2.000 Differs Round Head Camlock with 2 Keys
- » Key Duplicate Support
- » Masterkey Support
- » Packaging: Nylon Bag + Corrugated Carton

STANDARD COLORS FOR THIS RANGE



- » Non-standard colors are available with price difference (extra charge)
- » Production codes are referring items completely in color Grey 7035



TÜVRheinland
CERTIFIED

www.tuv.com
ID 1111220176

Monoblock

Flatpack

Powder Coated

Key Lock

Cleaning

Warranty



view						
combination	Cloakroom MCL	Cloakroom MCL	Cloakroom MCL	Cloakroom MCL	Cloakroom SHC	Cloakroom SHC
cupboard	1 x MCL/YVD.5(1.5).30	2 x MCL/YVD.5(1.5).30	1 x MCL/YVD.5(1.5).40	2 x MCL/YVD.5(1.5).40	1 x SHC/YVD.5(1.5).40	2 x SHC/YVD.5(1.5).40
vestiary set	1 x VST.6050	1 x VST.6050	1 x VST.6050	1 x VST.6050	1 x VST.6045	1 x VST.6045
vestiary side	1 x VSS.18050	n/a	1 x VSS.18050	n/a	1 x VSS.19045	n/a
height (mm)	1800	1800	1800	1800	1900	1900
width (mm)	915 (315+600)	1230 (315+600+315)	1015 (415+600)	1430 (415+600+415)	1015 (415+600)	1430 (415+600+415)
depth (mm)	500	500	500	500	450	450

catalogue code	production code
MCL/YVD.5(1.5).30	152M0602-00058
MCL/YVD.5(1.5).40	152M0602-00059
SHC/YVD.5(1.5).40	152M0604-00010
VST.6050	152M9909-00141
VST.6045	152M9909-00179
VSS.18050	152M9909-00145
VSS.19045	152M9909-00180

* These cloakrooms are composed of various parts and should be ordered separately.

FEATURES

- » Durable Welded Metal Construction
- » Electrostatic Powder Coating
- » 1 and 2 Rows Models
- » Rear Mounting Holes
- » Wooden Slat with Hook under Lockers in Equal Number to Compartments
- » Reinforced Doors with Concealed Hinges and Anti-Noise Plastic Buffers
- » Stamped Label Holder on Doors
- » 2.000 Differs Round Head Camlock with 2 Keys
- » Key Duplicate Support
- » Masterkey Support
- » Packaging: Nylon Bag + Corrugated Carton

OPTIONAL

- » Bolting Holes on Sides to Connect Cupboards [Fixing Kit is Not Included]
- » Envelope Hole on Doors
- » Coin Lock
- » Keypad Combination Lock
- » Wheel Combination Lock
- » Latchlock
- » Flush Latchlock

STANDARD COLORS FOR THIS RANGE



- » Non-standard colors are available with price difference (extra charge)
- » Production codes are referring items completely in color Grey 7035

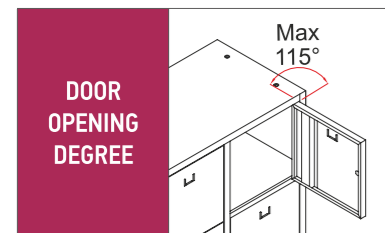

Monoblock



Powder Coated



Key Lock



Cleaning



Warranty



LOCKERS						
view						
catalogue code	WLC.3(3.1).40	WLC.6(3.2).40	WLC.4(4.1).40	WLC.8(4.2).40	WLC.5(5.1).40	WLC.10(5.2).40
production code	152M0604-00011	152M0604-00012	152M0604-00013	152M0604-00014	152M0604-00015	152M0604-00016
no of door	3	6	4	8	5	10
height (mm)	400	737	400	737	400	737
width (mm)	1185	1185	1570	1570	1955	1955
depth (mm)	450	450	450	450	450	450

SLATS WITH HOOKS						
view						
catalogue code	STH.3.119	STH.6.119	STH.4.157	STH.8.157	STH.5.196	STH.10.196
production code	152M9702-00004	152M9702-00005	152M9702-00006	152M9702-00007	152M9702-00008	152M9702-00009
no of hook	3	6	4	8	5	10
height (mm)	110	110	110	110	110	110
width (mm)	1185	1185	1570	1570	1955	1955

FEATURES

- » Durable Welded Metal Construction
- » Electrostatic Powder Coating
- » Ideal for Small Valuables
- » 5/6/7/8/9/10 Doors Models
- » Wall Mounting Holes on Rear Top
- » Doors with Anti-Noise Plastic Buffers
- » Stamped Label Holder on Doors
- » 2.000 Differs Round Head Camlock with 2 Keys
- » Key Duplicate Support
- » Masterkey Support
- » Packaging: Nylon Bag + Corrugated Carton

OPTIONAL

- » Coin Lock
- » Wheel Combination Lock

IDEAL FOR
SCHOOLS

STANDARD COLORS FOR THIS RANGE



- » Non-standard colors are available with price difference (extra charge)
- » Production codes are referring items completely in color Grey 7035



Monoblock



Powder Coated



Key Lock



Cleaning



Warranty

1/5 SERIES





view							
catalogue code	PEL.5(1.5)	PEL.10(2.5)	PEL.15(3.5)	PEL.20(4.5)	PEL.25(5.5)	PEL.30(6.5)	PEL.35(7.5)
production code	152M0602-00060	152M0602-00061	152M0602-00062	152M0602-00063	152M0602-00064	152M0602-00065	152M0602-00066
no of door	5	10	15	20	25	30	35
height (mm)	1108	1108	1108	1108	1108	1108	1108
width (mm)	218	412	606	800	992	1187	1381
depth (mm)	150	150	150	150	150	150	150

1/6 SERIES



view				
catalogue code	PEL.6(1.6)	PEL.12(2.6)	PEL.18(3.6)	PEL.24(4.6)
production code	152M0602-00067	152M0602-00068	152M0602-00069	152M0602-00070
no of door	6	12	18	24
height (mm)	1300	1300	1300	1300
width (mm)	218	412	606	800
depth (mm)	150	150	150	150





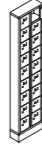

1/7 SERIES

view				
catalogue code	PEL.7(1.7)	PEL.14(2.7)	PEL.21(3.7)	PEL.28(4.7)
production code	152M0602-00071	152M0602-00072	152M0602-00073	152M0602-00074
no of door	7	14	21	28
height (mm)	1491	1491	1491	1491
width (mm)	218	412	606	800
depth (mm)	150	150	150	150





1/9 SERIES

view				
catalogue code	PEL.9(1.9)	PEL.18(2.9)	PEL.27(3.9)	PEL.36(4.9)
production code	152M0602-00079	152M0602-00080	152M0602-00081	152M0602-00082
no of door	9	18	27	36
height (mm)	1873	1873	1873	1873
width (mm)	218	412	606	800
depth (mm)	150	150	150	150

1/8 SERIES

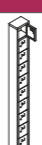
view				
catalogue code	PEL.8(1.8)	PEL.16(2.8)	PEL.24(3.8)	PEL.32(4.8)
production code	152M0602-00075	152M0602-00076	152M0602-00077	152M0602-00078
no of door	8	16	24	32
height (mm)	1682	1682	1682	1682
width (mm)	218	412	606	800
depth (mm)	150	150	150	150

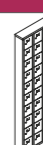
1/10 SERIES

view				
catalogue code	PEL.10(1.10)	PEL.20(2.10)	PEL.30(3.10)	PEL.40(4.10)
production code	152M0602-00083	152M0602-00084	152M0602-00085	152M0602-00086
no of door	10	20	30	40
height (mm)	2064	2064	2064	2064
width (mm)	218	412	606	800
depth (mm)	150	150	150	150

FEATURES

- » Durable Welded Metal Construction
- » Electrostatic Powder Coating
- » Wall Mounting Holes on Rear Top
- » Stamped Label Holder on Doors
- » 2.000 Differs Round Head Camlock with 2 Keys
- » Key Duplicate Support
- » Masterkey Support
- » Packaging: Nylon Bag + Corrugated Carton

OPTIONAL

- » Coin Lock (Except Models with Master Door)
- » Bolting Holes on Sides to Connect Cupboards [Fixing Kit is Not Included]
- » 200 mm Sloping Roof [Fixing by Bolt]
- » 100 mm Base [Fixing by Bolt]
- » 100 mm Feet [Welded or Fixing by Bolt on Request]
- » 100 mm Framed Feet [Fixing by Bolt]

STANDARD COLORS FOR THIS RANGE



- » Non-standard colors are available with price difference (extra charge)
- » Production codes are referring items completely in color Grey 7035

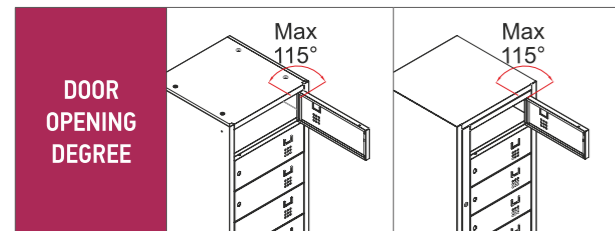

Monoblock

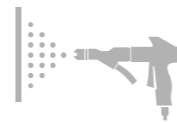

Powder Coated



Key Lock



Cleaning



Warranty



view				
catalogue code	LSL.5(1.5)	LSL/MD.5(1.5)	LSL.10(1.10)	LSL/MD.10(1.10)
production code	152M0602-00087	152M0602-00088	152M0602-00089	152M0602-00090
no of door	5	5	10	10
height (mm)	955	955	1800	1800
width (mm)	500	500	500	500
depth (mm)	500	500	500	500

FEATURES

- » Durable Welded Metal Construction
- » Electrostatic Powder Coating
- » Wall Mounting Holes on Rear Top
- » Stamped Label Holder on Doors
- » 2.000 Differs Round Head Camlock with 2 Keys
- » Key Duplicate Support
- » Masterkey Support
- » Packaging: Nylon Bag + Corrugated Carton

STANDARD COLORS FOR THIS RANGE

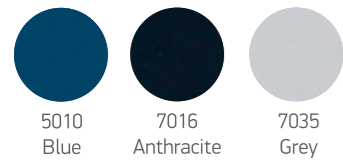

- » Non-standard colors are available with price difference (extra charge)
- » Production codes are referring items completely in color Grey 7035

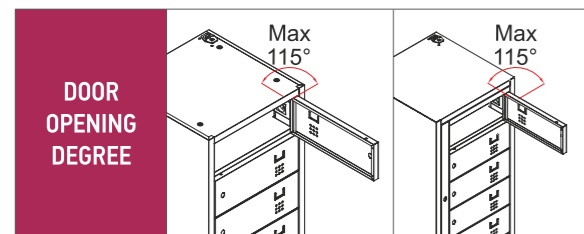

OPTIONAL

- » Coin Lock (Except Models with Master Door)
- » Bolting Holes on Sides to Connect Cupboards [Fixing Kit is Not Included]
- » 200 mm Sloping Roof [Fixing by Bolt]
- » 100 mm Base [Fixing by Bolt]
- » 100 mm Feet [Welded or Fixing by Bolt on Request]
- » 100 mm Framed Feet [Fixing by Bolt]



Monoblock



Powder Coated



Key Lock



Cleaning



Warranty



view				
catalogue code	LCL.5(1.5)	LCL/MD.5(1.5)	LCL.10(1.10)	LCL/MD.10(1.10)
production code	152M0602-00091	152M0602-00092	152M0602-00093	152M0602-00094
no of door	5	5	10	10
height (mm)	955	955	1800	1800
width (mm)	500	500	500	500
depth (mm)	500	500	500	500

APPLICABLE ON BELOW RANGES

- » MULTI-CASE LOCKERS
- » SCHOOL CUPBOARDS
- » CLOAKROOM STORAGE UNITS
- » WALL LOCKERS

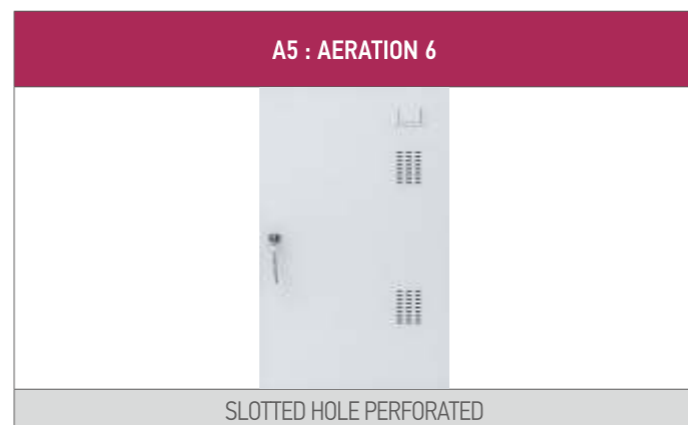
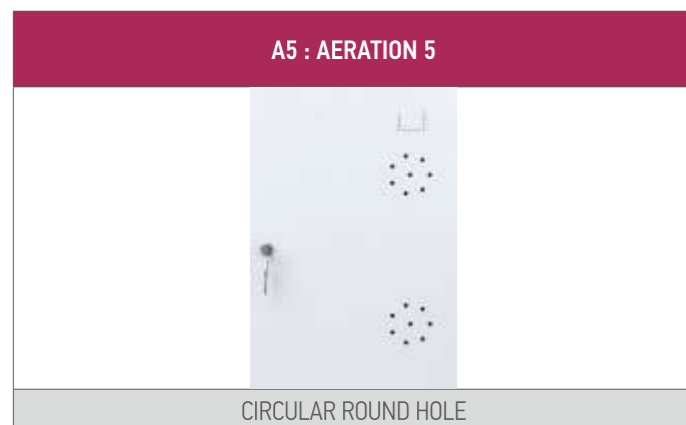
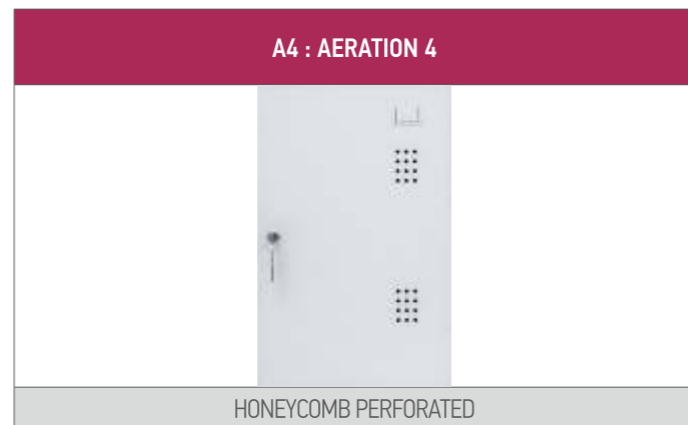
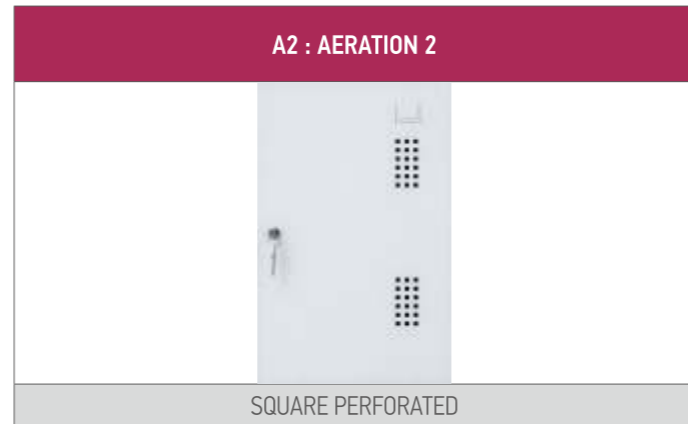

* Please add "A number" at the end of regular code of the item you need

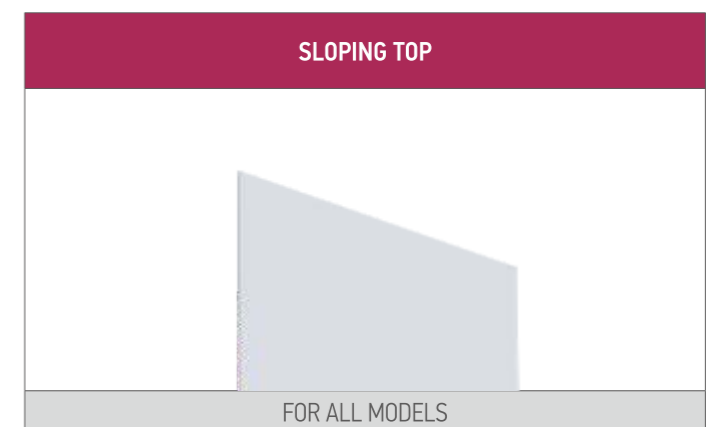

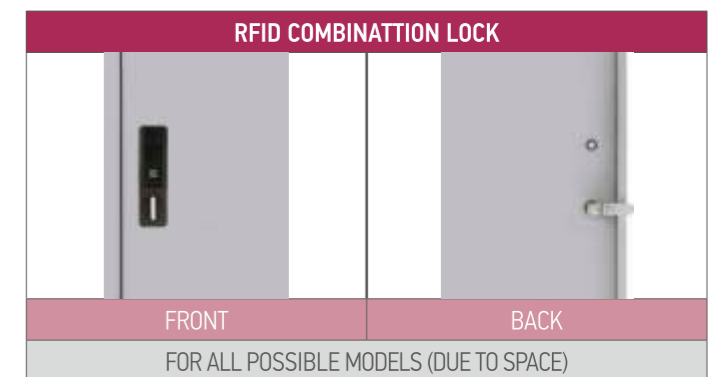
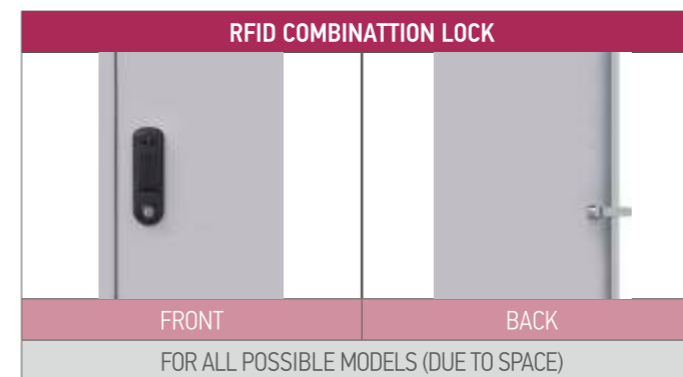
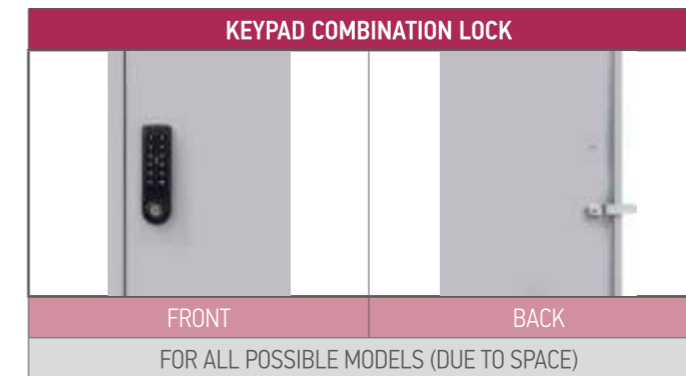
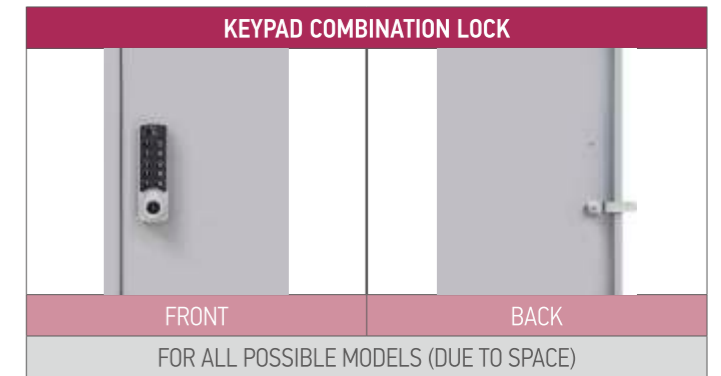
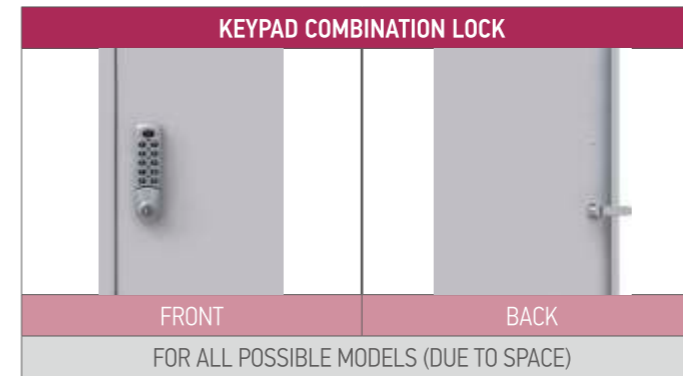
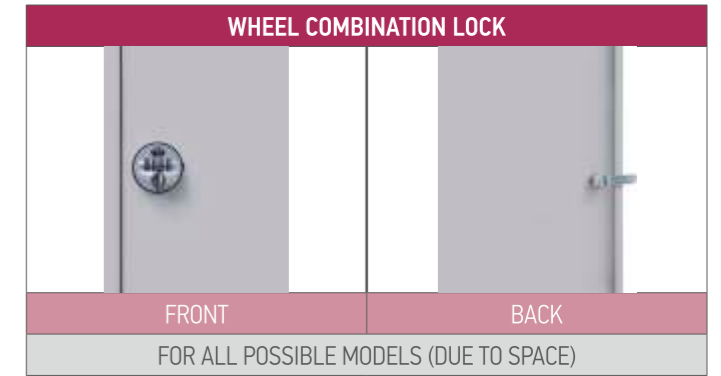
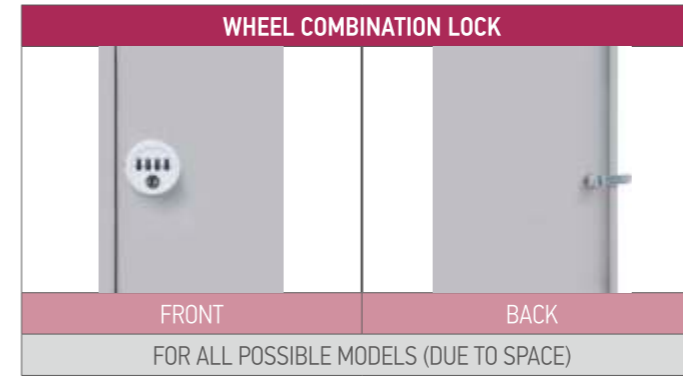
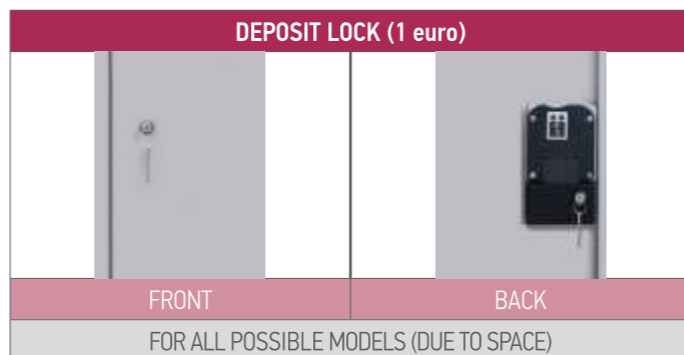
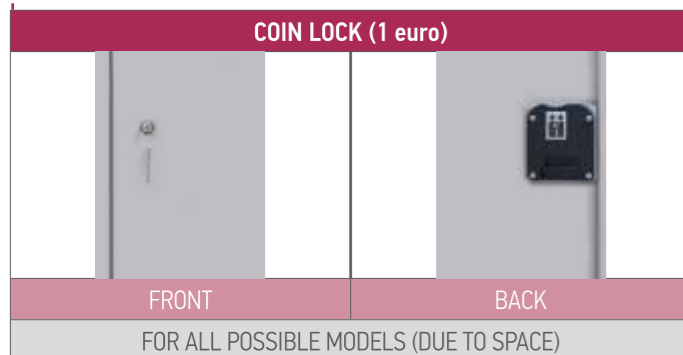
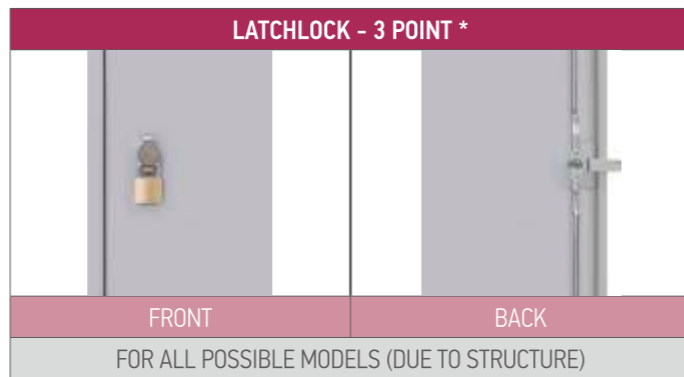
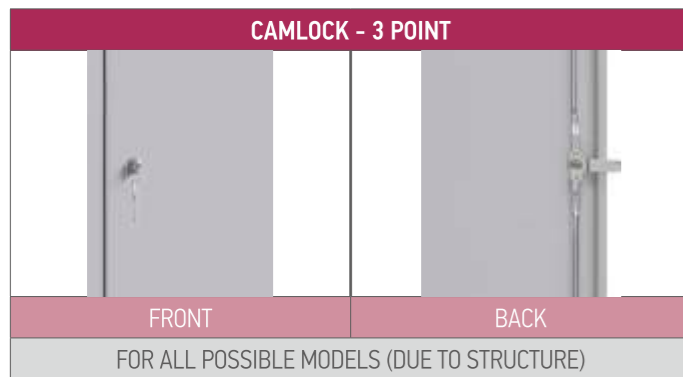
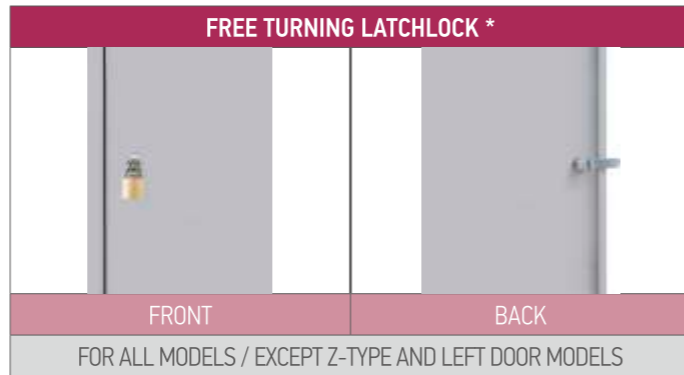
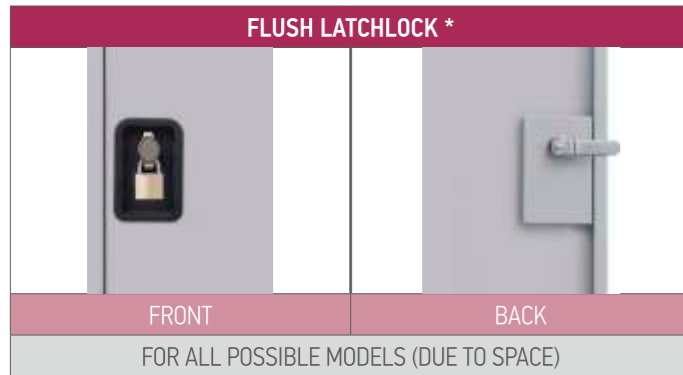
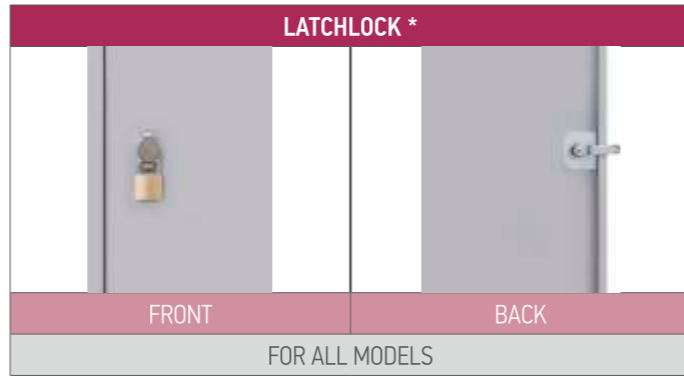
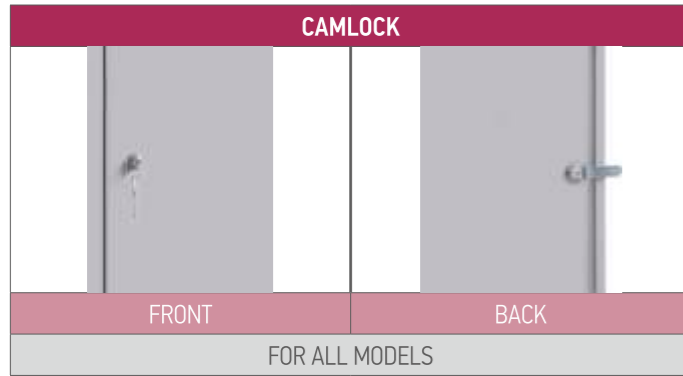

* Padlocks are not supplied together with latchlocks.

* Before ordering please ask stock availability of locks in these ranges.

**LAUNDRY &
CLEANING
CUPBOARDS**

FEATURES

- » Durable Welded Metal Construction
- » Electrostatic Powder Coating
- » Wall Mounting Holes on Rear Top
- » Stamped Label Holder on Doors
- » Air Slots on Back for Air Circulation
- » Master Door
- » 2.000 Differs Round Head Camlock with 2 Keys
- » Key Duplicate Support
- » Masterkey Support
- » Packaging: Nylon Bag + Corrugated Carton

OPTIONAL

- » 200 mm Sloping Roof [Fixing by Bolt]
- » 100 mm Base [Fixing by Bolt]
- » 100 mm Feet [Welded or Fixing by Bolt on Request]
- » 100 mm Framed Feet [Fixing by Bolt]
- » Wheel Combination Lock

STANDARD COLORS FOR THIS RANGE



» Non-standard colors are available with price difference (extra charge)
 » Production codes are referring items completely in color Grey 7035

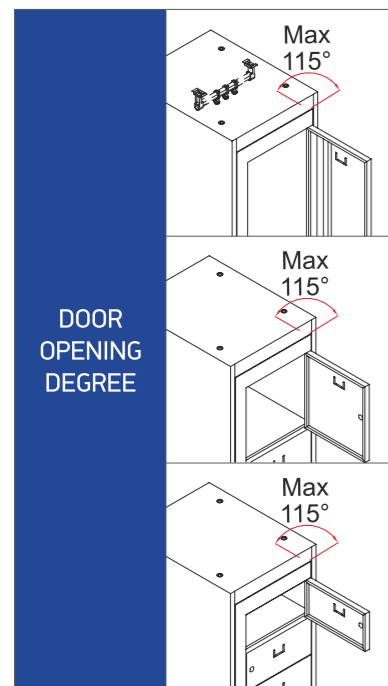

Monoblock

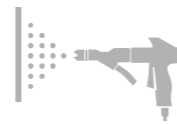

Powder Coated



Aeration



Key Lock



Cleaning



Warranty





1 COLUMN								
view								
catalogue code	LRC.3(1.3).40	LRC.4(1.4).40	LRC.5(1.5).40	LRC.6(1.6).40	LRC.7(1.7).40	LRC.8(1.8).40	LRC.9(1.9).40	LRC.10(1.10).40
production code	152M0801-00001	152M0801-00002	152M0801-00003	152M0801-00004	152M0801-00005	152M0801-00006	152M0801-00007	152M0801-00008
no of door	3	4	5	6	7	8	9	10
height (mm)	1800	1800	1800	1800	1800	1800	1800	1800
width (mm)	400	400	400	400	400	400	400	400
depth (mm)	500	500	500	500	500	500	500	500

2 COLUMNS								
view								
catalogue code	LRC.6(2.3).40	LRC.8(2.4).40	LRC.10(2.5).40	LRC.12(2.6).40	LRC.14(2.7).40	LRC.16(2.8).40	LRC.18(2.9).40	LRC.20(2.10).40
production code	152M0801-00009	152M0801-00010	152M0801-00011	152M0801-00012	152M0801-00013	152M0801-00014	152M0801-00015	152M0801-00016
no of door	6	8	10	12	14	16	18	20
height (mm)	1800	1800	1800	1800	1800	1800	1800	1800
width (mm)	738	738	738	738	738	738	738	738
depth (mm)	500	500	500	500	500	500	500	500

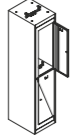

WITH COAT RAIL

view			
catalogue code	LRC.2(1.2).40	LRC.4(2.2).40	LRC.6(3.2).18066
production code	152M0801-00017	152M0801-00018	152M0801-00019
no of door	2	4	6
height (mm)	1800	1800	1800
width (mm)	400	738	660
depth (mm)	500	500	500

ACCESSORIES / ROOF



catalogue code	production code	height	width	depth
LRR.400	152M9910-00001	200	400	500
LRR.660	152M9910-00002	200	660	500
LRR.738	152M9910-00003	200	738	500

FEATURES

- » Durable Welded Metal Construction
- » Electrostatic Powder Coating
- » Wall Mounting Hole on Rear Top
- » Reinforced Doors with Semi-Concealed Hinges and Anti-Noise Plastic Buffers
- » Hinged Small Lid on Top with Magnet for Garment Input
- » Telescopic Frame with Bag Hook
- » Slots on Door for Air Circulation
- » 2.000 Differs Round Head Camlock with 2 Keys
- » Key Duplicate Support
- » Masterkey Support
- » Packaging: Nylon Bag + Corrugated Carton

STANDARD COLORS FOR THIS RANGE

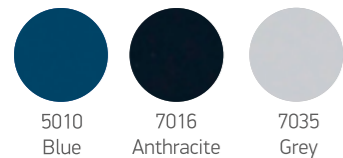

- » Non-standard colors are available with price difference (extra charge)
- » Production codes are referring items completely in color Grey 7035

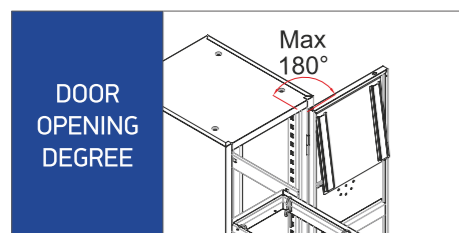

OPTIONAL

- » 200 mm Sloping Roof [Fixing by Bolt]
- » 100 mm Base [Fixing by Bolt]
- » 100 mm Feet [Welded or Fixing by Bolt on Request]
- » 100 mm Framed Feet [Fixing by Bolt]



Monoblock

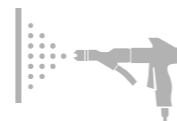

Powder Coated



Aeration



Key Lock



Cleaning



Warranty



view		
catalogue code	GRC/1.1840	GRC/1.1860
production code	152M0801-00020	152M0801-00021
no of door	1	1
no of shelf	1	1
height (mm)	1800	1800
width (mm)	415	600
depth (mm)	500	500

ACCESSORIES / ROOF				
catalogue code	production code	height	width	depth
WRR.40	152M9909-00046	200	415	500
WRR.60	152M9909-00012	200	600	500

* Bag is not supplied

FEATURES

- » Durable Welded Metal Construction
- » Electrostatic Powder Coating
- » Wall Mounting Holes on Rear Top
- » Full or Half Divider Models
- » Adjustable Shelves on Left
- » Top Shelf with Coat Rail and Hook on Right
- » Reinforced Doors with Concealed Hinges and Anti-Noise Plastic Buffers
- » Stamped Label Holder on Door
- » Louvered Doors for Air Circulation
- » 2.000 Differs Round Head Camlock with 2 Keys
- » Key Duplicate Support
- » Masterkey Support
- » Packaging: Nylon Bag + Corrugated Carton

OPTIONAL

- » 2.000 Differs 3 Point Round Head Camlock with 2 Keys
- » 200 mm Sloping Roof [Fixing by Bolt]
- » 100 mm Base [Fixing by Bolt]
- » 100 mm Feet [Welded or Fixing by Bolt on Request]

STANDARD COLORS FOR THIS RANGE



» Non-standard colors are available with price difference (extra charge)
 » Production codes are referring items completely in color Grey 7035

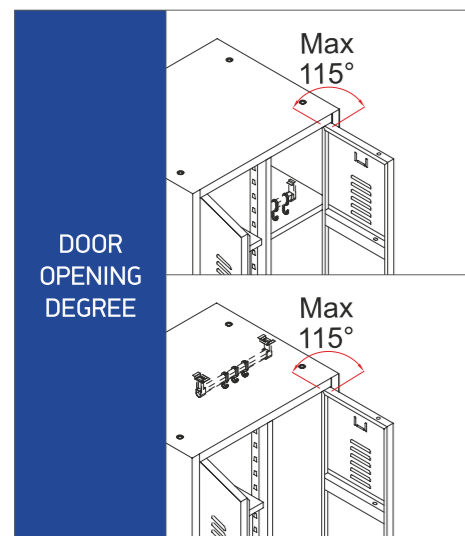

Monoblock



Powder Coated



Aeration



Key Lock



Cleaning



Warranty



view				
catalogue code	CLC/FD.1860	CLC/FD.1880	CLC/HD.1860	CLC/HD.1880
production code	152M0802-00001	152M0802-00002	152M0802-00003	152M0802-00004
no of door	2 swing	2 swing	2 swing	2 swing
divider	full divider	full divider	half divider	half divider
coat rail	right under shelf	right under shelf	right under top	right under top
shelves	4 left	4 left	4 left	4 left
height (mm)	1800	1800	1800	1800
width (mm)	600	800	600	800
depth (mm)	500	500	500	500

view				
catalogue code	CLC/2D10C.1860	CLC/2D10C.1880	CLC/FS4S.1860	CLC/FS4S.1880
production code	152M0802-00005	152M0802-00006	152M0802-00007	152M0802-00008
no of door	2 swing	2 swing	2 swing	2 swing
divider	full divider	full divider	n/a	n/a
coat rail	n/a	n/a	n/a	n/a
shelves	4 right + 4 left	4 right + 4 left	4 full size	4 full size
height (mm)	1800	1800	1800	1800
width (mm)	600	800	600	800
depth (mm)	500	500	500	500

**WORKSHOP &
INDUSTRIAL
FURNITURE**

FEATURES

- » Durable Welded Metal Construction
- » Electrostatic Powder Coating
- » On Four Heavy Duty Rollers
- » Lift-Off Hinged Top Door with Transparent Monitor Display
- » Roll-Out Keyboard Drawer
- » Sliding Mouse Tray
- » Roll-Out Shelf
- » Bottom Case for CPU with Swing Doors
- » Anti-Noise Plastic Buffers on Doors
- » Ventilation Holes on Side & Rear Panels
- » 2.000 Differs Paired Locks with 2 Keys
- » Key Duplicate Support
- » Masterkey Support
- » Packaging: Nylon Bag + Corrugated Carton

STANDARD COLORS FOR THIS RANGE

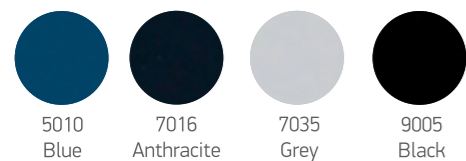

- » Non-standard colors are available with price difference (extra charge)
- » Production codes are referring items completely in color Grey 7035

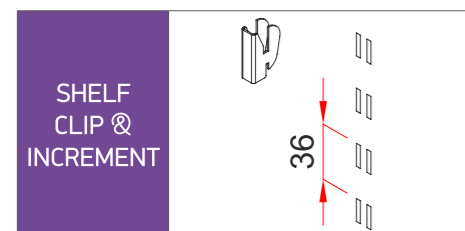
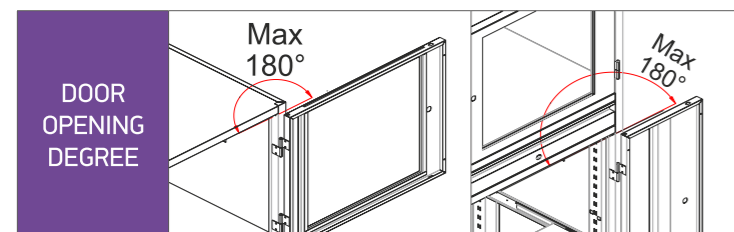

Monoblock



Powder Coated



Key Lock



Aeration



Cleaning



Warranty

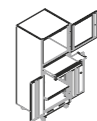
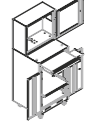
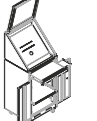

view			
catalogue code	IPC-0001	IPC-0002	IPC-0003
production code	152M0902-00001	152M0902-00002	152M0902-00003
height (mm)	1680	1710	1680
width (mm)	680	680	680
depth (mm)	600	600	600

FEATURES

- » Durable Welded Metal Construction
- » Electrostatic Powder Coating
- » Mobile and Stationary Models
- » Pull Handle on Left on Mobile Models
- » Anti-Tilt Drawers on Full-Extension Telescopic Slides
- » Slotted Drawers for Divider (without Divider)
- » Tray Shelf in Models having Door
- » Central Locking System
- » 2.000 Differs Square Head Pedestal Lock with 2 Keys for Drawers
- » 2.000 Differs Square Head Camlock with 2 Keys for Doors
- » Paired Locks in 2 Column Models
- » Key Duplicate Support
- » Masterkey Support
- » Packaging: Strech Wrapped & Delivery on Pallet

OPTIONAL

- » Drawer Dividers
- » 30 mm Finger Joint Top

STANDARD COLORS FOR THIS RANGE

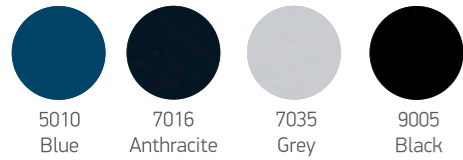

- » Non-standard colors are available with price difference (extra charge)
- » Production codes are referring items completely in color Grey 7035



Monoblock



Powder Coated



Key Lock



Cleaning



Warranty



MOBILE TOOL CABINETS							
view							
catalogue code	WSC-0102	WSC-0103	WSC-0104	WSC-0113	WSC-0114	WSC-0105	WSC-0121
production code	152M0901-00001	152M0901-00002	152M0901-00003	152M0901-00004	152M0901-00005	152M0901-00006	152M0901-00007
no of drawer	5	5	5	5	5	10	10
height of drawers (mm)	75(x1) 100(x2) 150(x1) 200(x1)	75(x1) 100(x2) 150(x1) 200(x1)	75(x1) 100(x2) 150(x1) 200(x1)	75(x1) 100(x2) 150(x1) 200(x1)	75(x1) 100(x2) 150(x1) 200(x1)	75(x1) 100(x2) 150(x1) 200(x1)	75(x2) 100(x4) 150(x2) 200(x2)
no of door	n/a	right door	left door	n/a	n/a	n/a	n/a
no of open case	n/a	n/a	n/a	right	left	n/a	n/a
no of shelf	n/a	1	1	1	1	n/a	n/a
wooden or tray top	n/a	n/a	n/a	n/a	n/a	n/a	n/a
no of divider	0	0	0	0	0	0	0
height (mm)	800	800	800	800	800	800	800
width (mm)	555	1090	1090	1090	1090	1090	1115
depth (mm)	600	600	600	600	600	600	600



* Dividers in above image are just for visual and do not represent the real color!

STATIONARY TOOL CABINETS					
view					
catalogue code	WSC-0106	WSC-0107	WSC-0108	WSC-0109	WSC-0110
production code	152M0901-00008	152M0901-00009	152M0901-00010	152M0901-00011	152M0901-00012
no of drawer	6	7	8	9	10
height of drawers (mm)	75(x1) 100(x3) 150(x1) 200(x1)	100(x2) 150(x4) 200(x1)	75(x2) 100(x2) 150(x3) 200(x1)	75(x2) 100(x5) 150(x1) 200(x1)	75(x4) 100(x5) 200(x1)
wooden or tray top	30 mm finger joint top	n/a	n/a	n/a	n/a
height (mm)	830	1110	1110	1110	1110
width (mm)	555	555	555	555	555
depth (mm)	600	600	600	600	600

DRAWER DIVIDERS (PLEXIGLASS)								
view								
catalogue code	WSCA-0016L	WSCA-0016T	WSCA-0017L	WSCA-0017T	WSCA-0018L	WSCA-0018T	WSCA-0019L	WSCA-0019T
production code	152M9911-00001	152M9911-00002	152M9911-00003	152M9911-00004	152M9911-00005	152M9911-00006	152M9911-00007	152M9911-00008
for drawers	75 mm high		100 mm high		150 mm high		200 mm high	
direction	longitudinal	transversal	longitudinal	transversal	longitudinal	transversal	longitudinal	transversal
channels	4 x 105 mm steps	4 x 94 mm steps	4 x 105 mm steps	4 x 94 mm steps	4 x 105 mm steps	4 x 94 mm steps	4 x 105 mm steps	4 x 94 mm steps
height (mm)	66	63	78	75	128	125	178	175
length (mm)	535	480	535	480	535	480	535	480
thickness (mm)	3	3	3	3	3	3	3	3

codes refer to only dividers (metal drawers are not included)

CONFIGURATION OF DIVIDERS							
1 x longitudinal	1 x transversal	2 x longitudinal	2 x transversal	3 x longitudinal	3 x transversal	4 x longitudinal	4 x transversal

FEATURES

- » Durable Welded Metal Construction
- » Electrostatic Powder Coating
- » 30 mm Finger Joint Top
- » 18 mm Finger Joint Top
- » 1-2-3-5 Drawer Blocks Combinations
- » Central Locking System
- » 2.000 Differs Square Head Pedestal Lock with 2 Keys
- » Key Duplicate Support
- » Masterkey Support
- » Workbench Packaging: Flatpack in Corrugated Carton
- » Drawer Block Packaging: Nylon Bag + Corrugated Carton

OPTIONAL

- » 18 mm Melamine Faced Chipboard Top
- » 18 mm Melamine Faced Chipboard Shelf

STANDARD COLORS FOR THIS RANGE

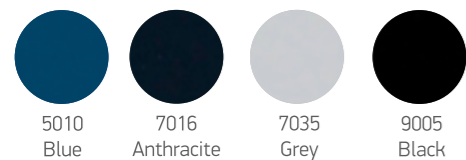

» Non-standard colors are available with price difference (extra charge)
 » Production codes are referring items completely in color Grey 7035



Flatpack



Powder Coated



Key Lock



Cleaning



Warranty

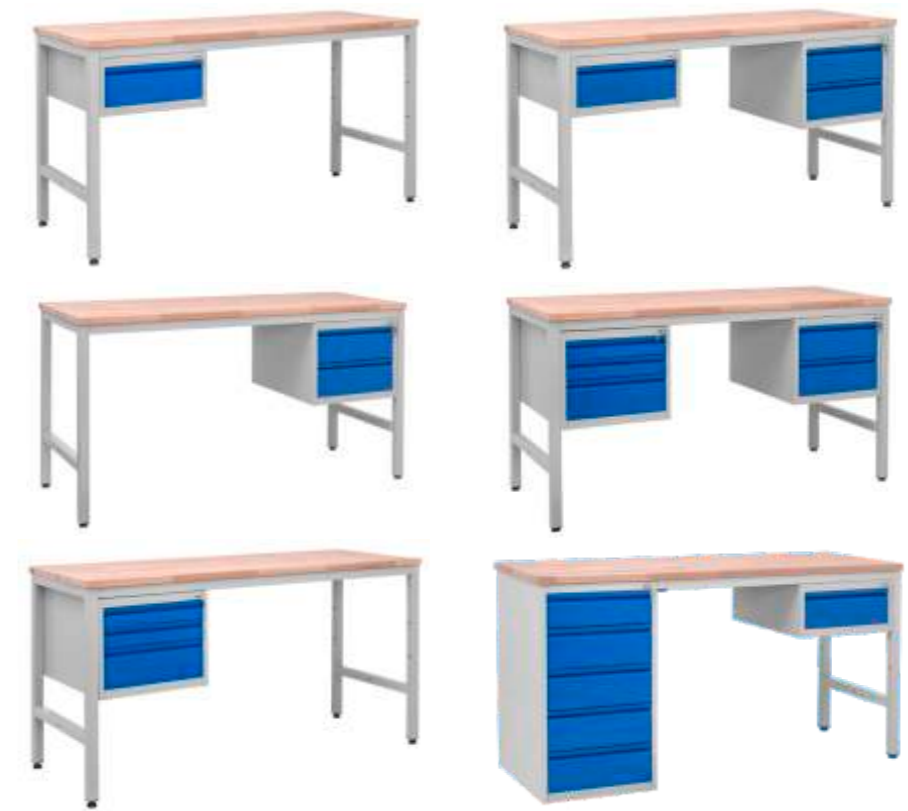

WORKBENCHES					
view					
catalogue code	WSB-0001	WSB-0002	WSB-0003	WSB-0004	WSB-0010
production code	152M0903-00001	152M0903-00002	152M0903-00003	152M0903-00004	152M0903-00005
frame type	full size frame		full size frame		half size frame
top	30 mm finger joint top	30 mm finger joint top	30 mm finger joint top	30 mm finger joint top	30 mm finger joint top
shelf	n/a	18 mm finger joint top	n/a	18 mm finger joint top	n/a
height (mm)	830	830	830	830	830
width (mm)	1200	1200	1600	1600	1600
depth (mm)	600	600	600	600	600

ITEMS ARE AVAILABLE IN 800 mm DEPTH BASED ON REQUEST & QUANTITY

PEDESTALS				
view				
catalogue code	WSP-0001	WSP-0002	WSP-0003	WSP-0007
production code	152M0903-00006	152M0903-00007	152M0903-00008	152M0903-00009
no of drawer	1	2	3	5
height of drawers (mm)	150(x1)	150(x2)	75(x2) 150(x1)	134(x1) 150(x4)
divider / per drawer	1	1	1	1
height (mm)	225	380	380	800
width (mm)	460	460	460	460
depth (mm)	585	585	585	585

ITEMS ARE AVAILABLE IN 785 mm DEPTH BASED ON REQUEST & QUANTITY



WALL MOUNT CUPBOARD		
view		
catalogue code	WSC-0111	WSC-0112
production code	152M0903-00010	152M0903-00011
item	wall mount cupboard	wall mount cupboard
height (mm)	600	600
width (mm)	1200	1600
depth (mm)	200	200



METAL PEGBOARD			
view			
catalogue code	WSCA-0020	WSCA-0021	WSCA-0022
production code	152M0903-00012	152M0903-00013	152M0903-00014
item	metal pegboard	metal pegboard	metal pegboard
height (mm)	300	600	900
width (mm)	1200	1200	1200
depth (mm)	31	31	31

view			
catalogue code	WSCA-0023	WSCA-0024	WSCA-0025
production code	152M0903-00015	152M0903-00016	152M0903-00017
item	metal pegboard	metal pegboard	metal pegboard
height (mm)	300	600	900
width (mm)	1600	1600	1600
depth (mm)	31	31	31

FEATURES

- » Durable Metal Construction
- » Electrostatic Powder Coating
- » Shelf Fronts with Full Size Label Holder
- » Divider Holes on Shelves
- » Plastic Dividers for Sorting
- » Packaging: Nylon Bag + Corrugated Carton

STANDARD COLORS FOR THIS RANGE

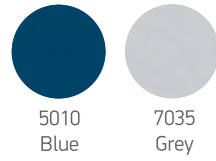

- » Non-standard colors are available with price difference (extra charge)
- » Production codes are referring items completely in color Grey 7035

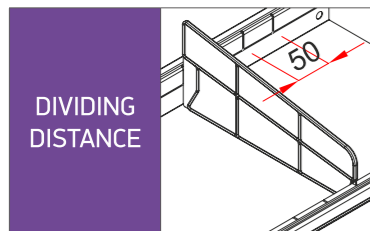

Monoblock

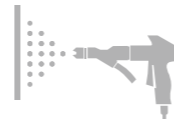

Powder Coated



Cleaning



Warranty



view							
catalogue code	MPSC [108.100.20].6	MPSC [108.100.30].6	MPSC [198.60.20].12	MPSC [198.60.30].12	MPSC [198.100.20].12	MPSC [198.100.30].12	MPSC [198.100.40].12
production code	152M0906-00001	152M0906-00002	152M0906-00003	152M0906-00004	152M0906-00005	152M0906-00006	152M0906-00007
no of shelves	6	6	12	12	12	12	12
no of dividers	36	36	48	48	72	72	72
height (mm)	1080	1080	1980	1980	1980	1980	1980
width (mm)	1000	1000	600	600	1000	1000	1000
depth (mm)	200	300	200	300	200	300	400

FEATURES

- » Durable Welded Metal Construction
- » Electrostatic Powder Coating
- » Wall Mounting Holes on Rear Top
- » Adjustable Shelves with Shelf Clip
- » Roll-Out Drawer
- » Reinforced Doors with Concealed Hinges and Anti-Noise Plastic Buffers
- » 1.000 Differs 3 Point Flush Handle Lock with 2 Keys
- » Key Duplicate Support
- » Masterkey Support
- » Packaging: Nylon Bag + Corrugated Carton

STANDARD COLORS FOR THIS RANGE

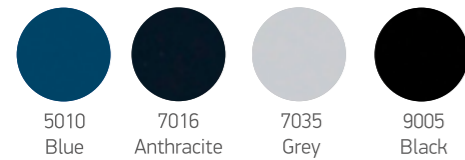

- » Non-standard colors are available with price difference (extra charge)
- » Production codes are referring items completely in color Grey 7035

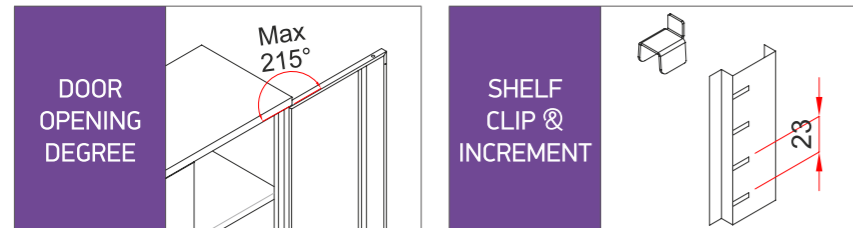

Monoblock



Powder Coated



Key Lock



Cleaning



Warranty

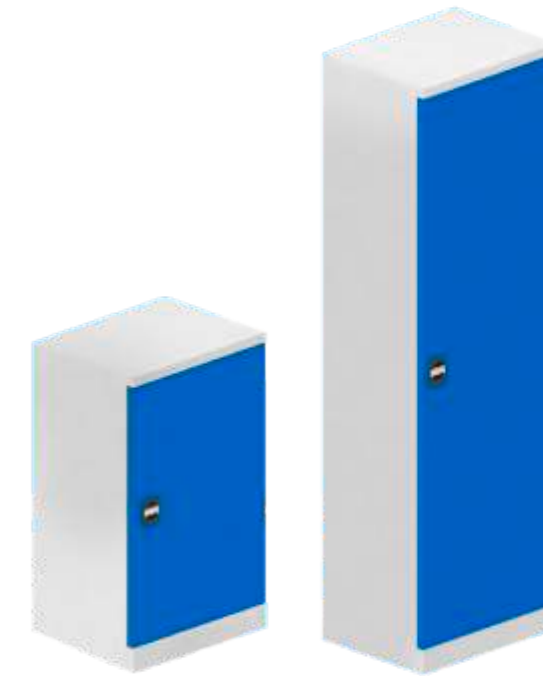

1000(h)*590(w) mm SERIES

view				
catalogue code	WSC-0001	WSC-0002	WSC-0003	WSC-0004
production code	152M0901-00013	152M0901-00014	152M0901-00015	152M0901-00016
type of door	1 right hand	1 right hand	1 right hand	1 right hand
no of shelf	2	1	1	n/a
no of drawer	n/a	2	3	4
height of drawers (mm)	n/a	112(x2)	89(x1) 112(x1) 158(x1)	89(x2) 112(x1) 158(x1)
height (mm)	1000	1000	1000	1000
width (mm)	590	590	590	590
depth (mm)	450	450	450	450

1950(h)*590(w) mm SERIES

view				
catalogue code	WSC-0005	WSC-0006	WSC-0007	WSC-0008
production code	152M0901-00017	152M0901-00018	152M0901-00019	152M0901-00020
type of door	1 right hand	1 right hand	1 right hand	1 right hand
no of shelf	4	3	3	3
no of drawer	n/a	2	3	3
height of drawers (mm)	n/a	158(x2)	112(x2) 158(x1)	112(x1) 158(x2)
height (mm)	1950	1950	1950	1950
width (mm)	590	590	590	590
depth (mm)	450	450	450	450



1000(h)*1000(w) mm SERIES							
view							
catalogue code	WSC-0009	WSC-0010	WSC-0011	WSC-0012	WSC-0013	WSC-0014	WSC-0015
production code	152M0901-00021	152M0901-00022	152M0901-00023	152M0901-00024	152M0901-00025	152M0901-00026	152M0901-00027
type of door	2 swing	2 swing	2 swing	2 swing	2 swing	2 swing	2 swing
divider	n/a	n/a	n/a	n/a	full divider	full divider	full divider
no of shelf	2	1	1	n/a	2	2	n/a
no of drawer	n/a	2	3	4	2	6	12
height of drawers (mm)	n/a	112(x2)	89(x1) 112(x1) 158(x1)	89(x2) 112(x1) 158(x1)	89(x2)	89(x1) 112(x2) 158(x3)	89(x2) 112(x4) 158(x6)
height (mm)	1000	1000	1000	1000	1000	1000	1000
width (mm)	1000	1000	1000	1000	1000	1000	1000
depth (mm)	450	450	450	450	450	450	450

1950(h)*1000(w) mm SERIES										
view										
catalogue code	WSC-0016	WSC-0017	WSC-0018	WSC-0019	WSC-0020	WSC-0021	WSC-0022	WSC-0023	WSC-0024	WSC-0025
production code	152M0901-00028	152M0901-00029	152M0901-00030	152M0901-00031	152M0901-00032	152M0901-00033	152M0901-00034	152M0901-00035	152M0901-00036	152M0901-00037
type of door	2 swing	2 swing	2 swing	2 swing	2 swing	2 swing	2 swing	2 swing	2 swing	2 swing
divider	n/a	n/a	n/a	n/a	n/a	n/a	full divider	full divider	full divider	full divider
no of shelf	4	3	3	3	3	2	8	6	6	6
no of drawer	n/a	2	3	3	3	5	n/a	4	4	6
height of drawers (mm)	n/a	158(x2)	112(x2) 158(x1)	112(x1) 158(x2)	89(x1) 112(x1) 158(x1)	89(x1) 112(x2) 158(x2)	n/a	112(x4)	158(x4)	89(x2) 112(x2) 158(x2)
height (mm)	1950	1950	1950	1950	1950	1950	1950	1950	1950	1950
width (mm)	1000	1000	1000	1000	1000	1000	1000	1000	1000	1000
depth (mm)	450	450	450	450	450	450	450	450	450	450

1950(h)*1200(w) mm SERIES										
view										
catalogue code	WSC-0026	WSC-0027	WSC-0028	WSC-0029	WSC-0030	WSC-0031	WSC-0032	WSC-0033	WSC-0034	WSC-0035
production code	152M0901-00038	152M0901-00039	152M0901-00040	152M0901-00041	152M0901-00042	152M0901-00043	152M0901-00044	152M0901-00045	152M0901-00046	152M0901-00047
type of door	2 swing	2 swing	2 swing	2 swing	2 swing	2 swing	2 swing	2 swing	2 swing	2 swing
divider	n/a	n/a	n/a	n/a	n/a	n/a	full divider	full divider	full divider	full divider
no of shelf	4	3	3	3	3	2	8	6	6	6
no of drawer	n/a	2	3	3	3	5	n/a	4	4	6
height of drawers (mm)	n/a	158(x2)	112(x2) 158(x1)	112(x1) 158(x2)	89(x1) 112(x1) 158(x1)	89(x1) 112(x2) 158(x2)	n/a	112(x4)	158(x4)	89(x2) 112(x2) 158(x2)
height (mm)	1950	1950	1950	1950	1950	1950	1950	1950	1950	1950
width (mm)	1200	1200	1200	1200	1200	1200	1200	1200	1200	1200
depth (mm)	450	450	450	450	450	450	450	450	450	450

FEATURES

- » Durable Welded Metal Construction
- » Electrostatic Powder Coating
- » Wall Mounting Holes on Rear Top
- » Adjustable Slotted Shelves with Shelf Clip
- » Shelf Dividers
- » Roll-Out Drawers
- » Divisible Drawers
- » Reinforced Doors with Concealed Hinges and Anti-Noise Plastic Buffers
- » 1.000 Differs 3 Point Flush Handle Lock with 2 Keys
- » Key Duplicate Support
- » Masterkey Support
- » Packaging: Nylon Bag + Corrugated Carton

OPTIONAL

- » Divider for Divisible Drawers

STANDARD COLORS FOR THIS RANGE

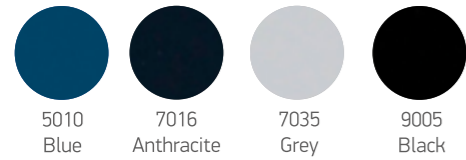

- » Non-standard colors are available with price difference (extra charge)
- » Production codes are referring items completely in color Grey 7035

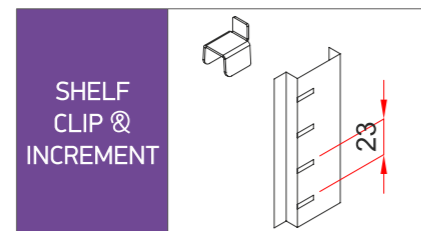
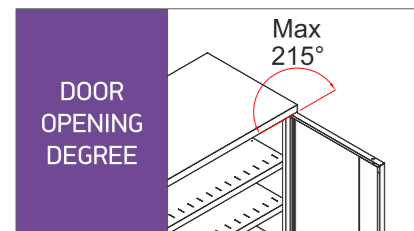

Monoblock

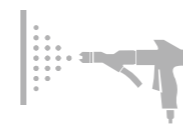

Powder Coated



Key Lock



Cleaning



Warranty



1000(h)*1000(w) mm SERIES			
view			
catalogue code	WSC-0036	WSC-0037	WSC-0038
production code	152M0901-00048	152M0901-00049	152M0901-00050
type of door	2 swing	2 swing	2 swing
no of shelf	3	2	2
no of shelf divider	n/a	n/a	n/a
height of shelf divider (mm)	n/a	n/a	n/a
no of drawer	n/a	1	2
height of drawers (mm)	n/a	110(x1)	65(x1) 110(x1)
height (mm)	1000	1000	1000
width (mm)	1000	1000	1000
depth (mm)	500	500	500



1950(h)*1000(w) mm SERIES				
view				
catalogue code	WSC-0039	WSC-0040	WSC-0041	WSC-0042
production code	152M0901-00051	152M0901-00052	152M0901-00053	152M0901-00054
type of door	2 swing	2 swing	2 swing	2 swing
no of shelf	2	6	5	6
no of shelf divider	n/a	6	8	7
height of shelf divider (mm)	n/a	200(x2) 246(x2) 315(x2)	110(x5) 200(x3)	110(x7)
no of drawer	4	1	5	5
height of drawers (mm)	65(x1) 110(x3)	110(x1)	65(x1) 110(x4)	65(x1) 110(x4)
no of divisible drawer	n/a	2	9	12
h*w of divisible drawers (mm)	n/a	150*445(x2)	100*145(x6) 100*295(x3)	100*145(x6) 100*295(x6)
height (mm)	1950	1950	1950	1950
width (mm)	1000	1000	1000	1000
depth (mm)	500	500	500	500

SHELF DIVIDERS (METAL)				
view				
catalogue code	WSCA-0007	WSCA-0026	WSCA-0027	WSCA-0028
production code	152M9911-00009	152M9911-00010	152M9911-00011	152M9911-00012
height (mm)	110	200	246	315
depth (mm)	375	375	375	375

DRAWER DIVIDERS (PLEXIGLASS)						
view						
catalogue code	WSCA-0009L	WSCA-0009T	WSCA-0011L	WSCA-0011T	WSCA-0014L	WSCA-0014T
production code	152M9911-00013	152M9911-00014	152M9911-00015	152M9911-00016	152M9911-00017	152M9911-00018
for drawers (h*w) mm	100*145		100*295		150*445	
direction	longitudinal	transversal	longitudinal	transversal	longitudinal	transversal
channels	3 x 110 mm steps	1 x 68 mm steps	3 x 110 mm steps	3 x 75 mm steps	3 x 110 mm steps	4 x 91 mm steps
height (mm)	96	93	96	93	143	140
length (mm)	435	140	435	289	435	440
thickness (mm)	3	3	3	3	3	3

Codes refer to only dividers (metal drawers are not included)

FEATURES

- » Durable Welded Metal Construction
- » Electrostatic Powder Coating
- » Wall Mounting Holes on Rear Top
- » Adjustable Slotted Shelves with Shelf Clip
- » Reinforced Doors with Concealed Hinges and Anti-Noise Plastic Buffers
- » 1.000 Differs 2 Point Flush Handle Lock with 2 Keys (Paired Lock)
- » Key Duplicate Support
- » Masterkey Support
- » Packaging: Nylon Bag + Corrugated Carton

STANDARD COLORS FOR THIS RANGE

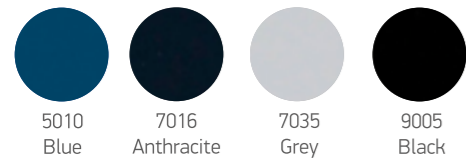

- » Non-standard colors are available with price difference (extra charge)
- » Production codes are referring items completely in color Grey 7035

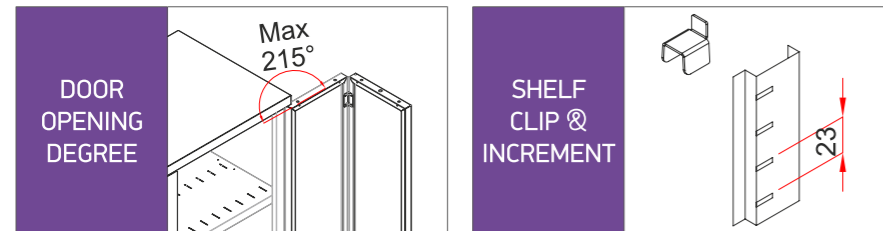

Monoblock



Powder Coated



Key Lock



Cleaning



Warranty



view		
catalogue code	WSC-0043	WSC-0044
production code	152M0901-00055	152M0901-00056
type of door	2 swing	2 swing
no of shelf	2	4
height (mm)	1000	1950
width (mm)	1000	1000
depth (mm)	500	500

FEATURES

- » Durable Welded Metal Construction
- » Electrostatic Powder Coating
- » Wall Mounting Holes on Rear Top
- » Adjustable Shelves with Shelf Clip
- » Perforated Panel with Spring Pin System
- » Reinforced Doors with Concealed Hinges and Anti-Noise Plastic Buffers
- » 1.000 Differs 3 Point Flush Handle Lock with 2 Keys
- » Key Duplicate Support
- » Masterkey Support
- » Packaging: Nylon Bag + Corrugated Carton

STANDARD COLORS FOR THIS RANGE

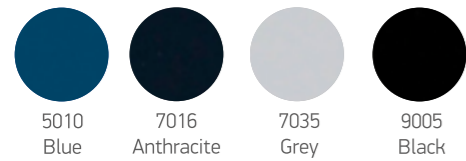

- » Non-standard colors are available with price difference (extra charge)
- » Production codes are referring items completely in color Grey 7035



Monoblock

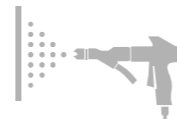

Powder Coated



Key Lock



Cleaning



Warranty



view						
catalogue code	WSC-0045	WSC-0046	WSC-0047	WSC-0048	WSC-0049	WSC-0050
production code	152M0901-00057	152M0901-00058	152M0901-00059	152M0901-00060	152M0901-00061	152M0901-00062
type of door	2 swing	2 swing	2 swing	2 swing	2 swing	2 swing
no of shelf	n/a	n/a	2	n/a	2	n/a
perforated panel	full	full	half	full	half	full
height (mm)	1000	1000	1950	1950	1950	1950
width (mm)	916	1200	916	916	1200	1200
depth (mm)	422	422	422	422	422	422

FEATURES

- » Durable Welded Metal Construction
- » Electrostatic Powder Coating
- » Ledgetop
- » Wall Mounting Holes on Rear Top
- » Adjustable Galvanized Shelves
- » Roll-Out Drawer
- » Reinforced Doors with Lift-Off Hinges and Anti-Noise Plastic Buffers
- » 100 mm Feet+Leveller [Fixing by Bolt]
- » 1.000 Differs Cylinder Lock with 2 Keys
- » Key Duplicate Support
- » Masterkey Support
- » Packaging: Nylon Bag + Corrugated Carton

STANDARD COLORS FOR THIS RANGE

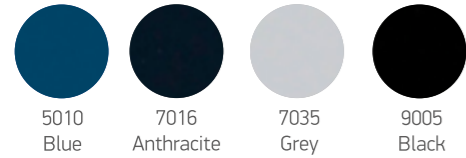

- » Non-standard colors are available with price difference (extra charge)
- » Production codes are referring items completely in color Grey 7035



Monoblock

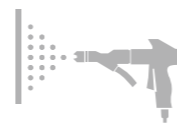

Powder Coated



Key Lock



Cleaning



Warranty



915(h)*533(w) mm SERIES						
view						
catalogue code	WSC-0057	WSC-0058	WSC-0059	WSC-0060	WSC-0061	WSC-0062
production code	152M0901-00069	152M0901-00070	152M0901-00071	152M0901-00072	152M0901-00073	152M0901-00074
type of door	1 right hand	1 right hand	1 right hand	1 right hand	2 right hand	2 right hand
no of shelf	2	2	2	2	2	2
no of drawer	n/a	n/a	1	1	n/a	n/a
height of drawers (mm)	n/a	n/a	120(x1)	120(x1)	n/a	n/a
feet	n/a	included	n/a	included	n/a	included
height (mm)	915	1015	915	1015	915	1015
width (mm)	533	533	533	533	533	533
depth (mm)	500	500	500	500	500	500



980(h)*430(w) mm SERIES

view		
catalogue code	WSC-0069	WSC-0070
production code	152M0901-00081	152M0901-00082
type of door	1 right hand	1 right hand
no of shelf	2	2
no of drawer	1	1
height of drawers (mm)	120(x2)	120(x2)
feet	n/a	included
height (mm)	980	1080
width (mm)	430	430
depth (mm)	340	340



915(h)*1000(w) mm SERIES

view						
catalogue code	WSC-0063	WSC-0064	WSC-0065	WSC-0066	WSC-0067	WSC-0068
production code	152M0901-00075	152M0901-00076	152M0901-00077	152M0901-00078	152M0901-00079	152M0901-00080
type of door	2 swing	2 swing	2 swing	2 swing	2 swing	2 swing
no of shelf	2	2	2	2	2	2
no of drawer	n/a	n/a	2	2	6	6
height of drawers (mm)	n/a	n/a	120(x2)	120(x2)	112(x4) 158(x2)	112(x4) 158(x2)
feet	n/a	included	n/a	included	n/a	included
height (mm)	915	1015	915	1015	915	1015
width (mm)	1000	1000	1000	1000	1000	1000
depth (mm)	500	500	500	500	500	500

ACCESSORIES

view						
catalogue code	WSCA-0001	WSCA-0002	WSCA-0003	WSCA-0004	WSCA-0005	WSCA-0006
production code	152M9911-00019	152M9911-00020	152M9911-00021	152M9911-00022	152M9911-00023	152M9911-00024
item	writing console		mobile base		rubber mat	
no of lid	1	2	n/a	n/a	n/a	n/a
height (mm)	230	230	125	125	528	995
width (mm)	525	990	538	1005	528	995
depth (mm)	495	495	505	505	495	495

FEATURES

- » Durable Welded Metal Construction
- » Electrostatic Powder Coating
- » Wall Mounting Holes on Rear Top
- » Adjustable Shelves with Shelf Clip
- » Reinforced Doors with Lift-Off Hinges and Anti-Noise Plastic Buffers
- » Levelling Feet
- » 1.000 Differs 3 Point Flush Handle Lock with 2 Keys
- » Key Duplicate Support
- » Masterkey Support
- » Packaging: Nylon Bag + Corrugated Carton

STANDARD COLORS FOR THIS RANGE

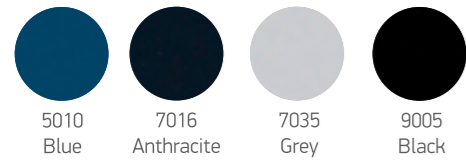

- » Non-standard colors are available with price difference (extra charge)
- » Production codes are referring items completely in color Grey 7035

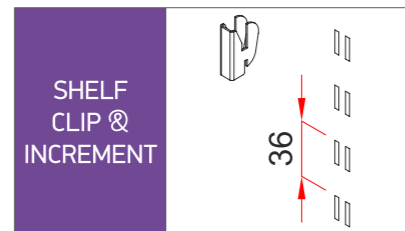
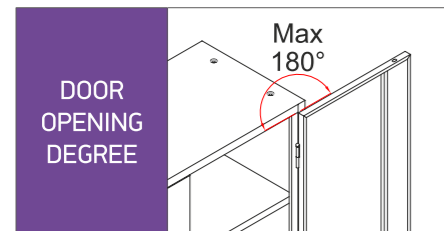

Monoblock

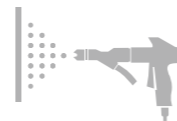

Powder Coated



Key Lock



Cleaning



Warranty



view				
catalogue code	WSC-0071	WSC-0072	WSC-0073	WSC-0074
production code	152M0901-00083	152M0901-00084	152M0901-00085	152M0901-00086
type of door	1 right hand	2 swing	1 right hand	2 swing
no of shelf	2	2	4	4
height (mm)	1060	1060	1950	1950
width (mm)	530	1000	530	1000
depth (mm)	450	450	450	450

FEATURES

- » Durable Welded Metal Construction
- » Electrostatic Powder Coating
- » Wall Mounting Holes on Rear Top
- » Adjustable Shelves with Shelf Clip
- » Louvered & Perforated Door
- » Louvered & Perforated Rear Panel
- » Doors with Lift-Off Hinges and Anti-Noise Plastic Buffers
- » Levelling Feet
- » 1.000 Differs 3 Point Flush Handle Lock with 2 Keys
- » Key Duplicate Support
- » Masterkey Support
- » Packaging: Nylon Bag + Corrugated Carton

STANDARD COLORS FOR THIS RANGE

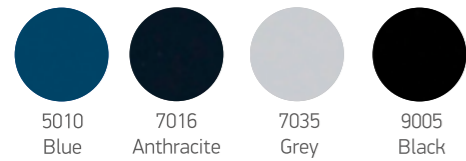

- » Non-standard colors are available with price difference (extra charge)
- » Production codes are referring items completely in color Grey 7035

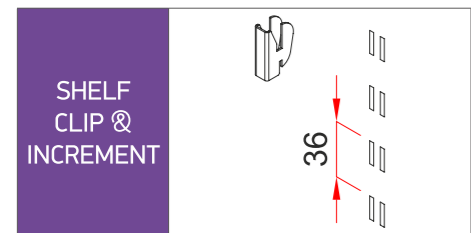
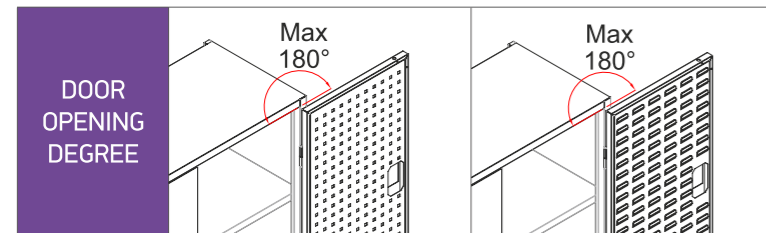

Monoblock



Powder Coated



Key Lock



Cleaning



Warranty



1060(h)*1000(w) mm SERIES				
view				
catalogue code	WSC-0075	WSC-0076	WSC-0077	WSC-0078
production code	152M0901-00087	152M0901-00088	152M0901-00089	152M0901-00090
type of door	2 swing perforated (full)	2 swing louvered (full)	2 swing perforated (full)	2 swing louvered (full)
type of back panel	standard	standard	perforated (full)	louvered (full)
no of shelf	2	2	n/a	n/a
height (mm)	1060	1060	1060	1060
width (mm)	1000	1000	1000	1000
depth (mm)	450	450	450	450

1950(h)*1000(w) mm SERIES						
view						
catalogue code	WSC-0079	WSC-0080	WSC-0081	WSC-0082	WSC-0083	WSC-0084
production code	152M0901-00091	152M0901-00092	152M0901-00093	152M0901-00094	152M0901-00095	152M0901-00096
type of door	2 swing perforated (full)	2 swing louvered (full)	2 swing perforated (full)	2 swing louvered (1/2)	2 swing perforated (full)	2 swing louvered (full)
type of back panel	standard	standard	perforated (full)	perforated (1/2)	perforated (full)	louvered (full)
no of regular shelf	4	4	1	2	n/a	n/a
no of divisible shelf	n/a	n/a	1	n/a	n/a	n/a
height (mm)	1950	1950	1950	1950	1950	1950
width (mm)	1000	1000	1000	1000	1000	1000
depth (mm)	450	450	450	450	450	450

FEATURES

- » Durable Welded Metal Construction
- » Electrostatic Powder Coating
- » Door & Drawer Combinations
- » Wall Mounting Holes on Rear Top
- » Adjustable Shelves
- » Reinforced Doors with Concealed Hinges and Anti-Noise Plastic Buffers
- » 1.000 Differs Cylinder Lock with 2 Keys
- » Key Duplicate Support
- » Masterkey Support
- » Packaging: Nylon Bag + Corrugated Carton

STANDARD COLORS FOR THIS RANGE

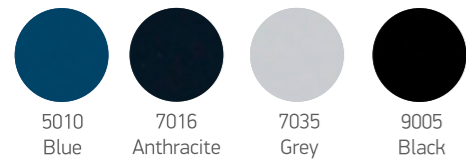

- » Non-standard colors are available with price difference (extra charge)
- » Production codes are referring items completely in color Grey 7035

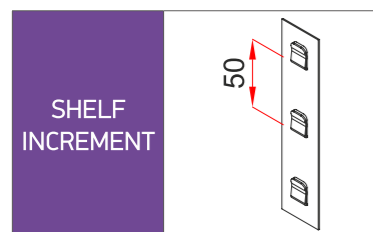
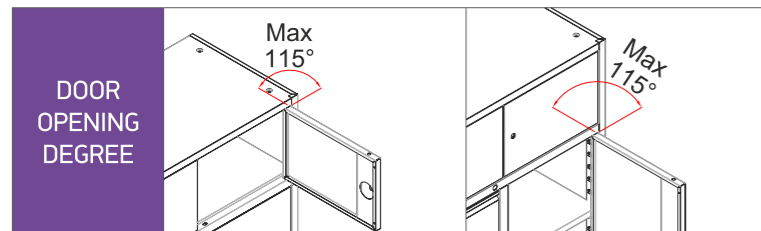

Warranty

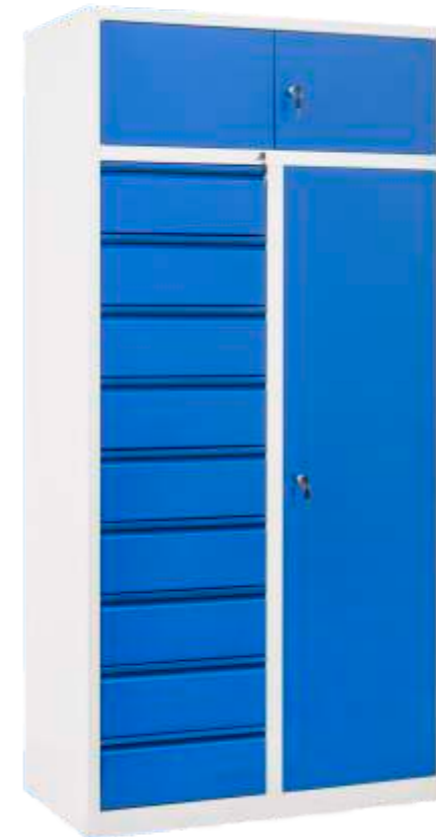

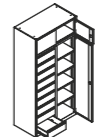
view	
catalogue code	WSC-0085
production code	152M0901-00097
type of top door	2 swing
type of right door	1 right hand
no of shelf	4
no of drawer	9
height of drawers (mm)	167
height (mm)	1950
width (mm)	945
depth (mm)	500

FEATURES

- » Durable Welded Metal Construction
- » Electrostatic Powder Coating
- » Wall Mounting Holes on Rear Top
- » Adjustable Shelves with Stiffener
- » Silent and Reinforced Sliding Metal Doors on Rollers
- » Central Partition on 1500 mm Wide Models
- » Levelling Feet
- » 1.000 Differs Push Lock with 2 Keys
- » Key Duplicate Support
- » Masterkey Support
- » Packaging: Nylon Bag + Corrugated Carton

STANDARD COLORS FOR THIS RANGE

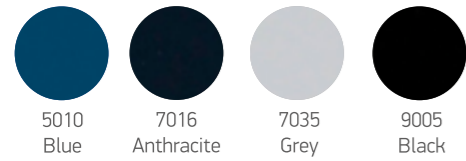

- » Non-standard colors are available with price difference (extra charge)
- » Production codes are referring items completely in color Grey 7035

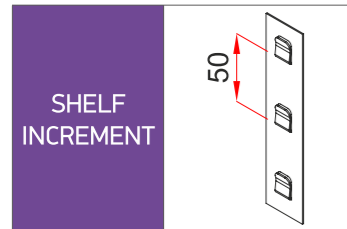

Monoblock

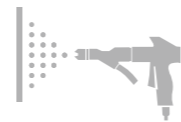

Powder Coated



Key Lock



Cleaning



Warranty



view								
catalogue code	WSC-0086	WSC-0087	WSC-0088	WSC-0089	WSC-0090	WSC-0091	WSC-0092	WSC-0093
production code	152M0901-00106	152M0901-00107	152M0901-00108	152M0901-00109	152M0901-00110	152M0901-00111	152M0901-00112	152M0901-00113
no of shelf	2	2	2+2	2+2	4	4	4+4	4+4
divider	n/a	n/a	full divider	full divider	n/a	n/a	full divider	full divider
height (mm)	1000	1000	1000	1000	2000	2000	2000	2000
width (mm)	1000	1000	1500	1500	1000	1000	1500	1500
depth (mm)	450	650	450	650	450	650	450	650

FEATURES

- » Durable Welded Metal Construction
- » Electrostatic Powder Coating
- » Adjustable Shelves with Holes
- » Liquid Leak Proof Collector Shelf with Welded Corners at the Bottom
- » Reinforced Doors with Lift-Off Hinges and Anti-Noise Plastic Buffers
- » Levelling Feet
- » 1.000 Differs 3 Point Flush Handle Lock with 2 Keys
- » Key Duplicate Support
- » Masterkey Support
- » Packaging: Nylon Bag + Corrugated Carton

OPTIONAL

- » T-Handle Lock

STANDARD COLORS FOR THIS RANGE

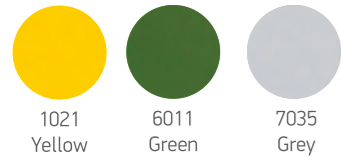

» Non-standard colors are available with price difference (extra charge)
 » Production codes are referring items completely in color Grey 7035

CUPBOARD COLOR GUIDE

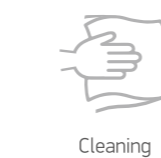
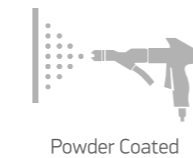
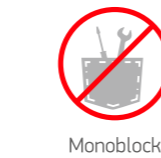
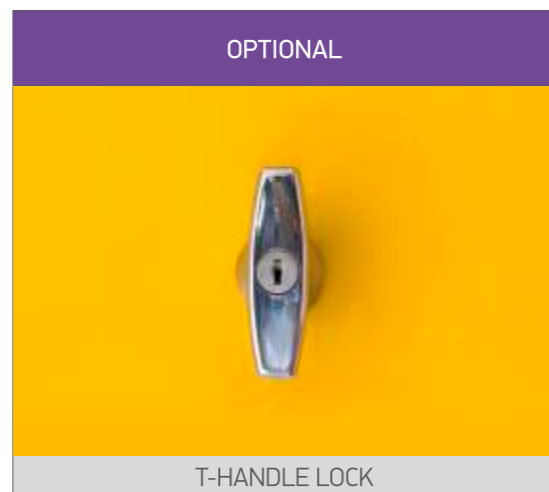
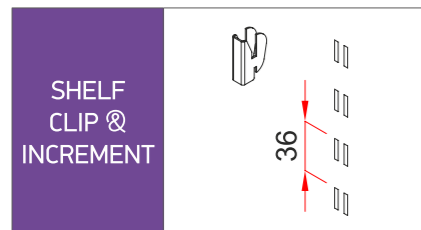

view					
catalogue code	CSC/OM.0735	CSC/OM.0945	CSC/OM.0791	CSC/OM.0991	CSC/OM.1891
production code	152M0904-00001	152M0904-00002	152M0904-00003	152M0904-00004	152M0904-00005
type of door	1 door	1 door	2 swing	2 swing	2 swing
no of shelf 30 mm (h)	1	1	1	1	3
no of shelf 82 mm (h)	1	1	1	1	1
height (mm)	700	900	700	900	1815
width (mm)	355	459	915	915	915
depth (mm)	305	459	459	459	459

view	
catalogue code	FRF-W/CSC/OM.91
production code	152M9911-00025
item	welded framed feet
height (mm)	460
width (mm)	920
depth (mm)	465



FEATURES

- » Durable Welded Metal Construction
- » Electrostatic Powder Coating
- » Liquid Leak Proof Shelves with Welded Corners
- » Reinforced Doors with Concealed Hinges and Anti-Noise Plastic Buffers
- » Square Perforated Doors for Air Circulation
- » Document Case on Door
- » 1.000 Differs 3 Point Flush Handle Lock with 2 Keys
- » Key Duplicate Support
- » Masterkey Support
- » Packaging: Nylon Bag + Corrugated Carton

STANDARD COLORS FOR THIS RANGE

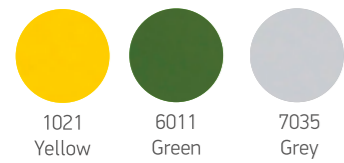

- » Non-standard colors are available with price difference (extra charge)
- » Production codes are referring items completely in color Grey 7035

CUPBOARD COLOR GUIDE

FLAMMABLE LIQUIDS

PESTICIDES & INSECTICIDES

HAZARDOUS WASTE MATERIALS

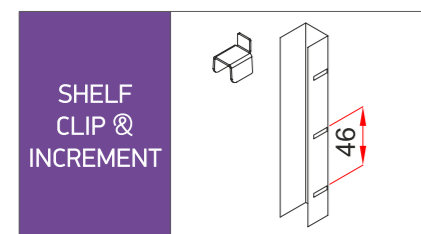

OPTIONAL

- » Filter Plate on Shelves
- » 100 mm High Collector Shelf



Monoblock

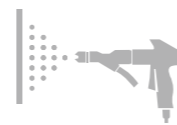

Powder Coated



Key Lock



Aeration



Cleaning



Warranty



view				
catalogue code	CSC.1050	CSC.1092	CSC.1950	CSC.1992
production code	152M0904-00006	152M0904-00007	152M0904-00008	152M0904-00009
no of doors	1 right hand	2 swing	1 right hand	2 swing
no of shelf 50 mm (h)	2	2	4	4
height (mm)	1000	1000	1950	1950
width (mm)	500	916	500	916
depth (mm)	422	422	422	422

SAFES

AS

- » Durable Welded Metal Construction
- » Electrostatic Powder Coating
- » Double Walls Filled with Rock Wool
- » Adjustable Shelves with A4 Suspension File Support
- » Intumescent Strip between Frame and Doors
- » 180 Degree Rotating Heavy Duty Hinged Doors
- » High Quality Safe Lock with 4 Direction Locking with 2 Keys
- » No Key Duplicate Support & No Masterkey Support
- » Packaging: Strech Wrapped & Delivery on Pallet

- » Inner Cupboards
- » Roll-Out Accessories

STANDARD COLORS FOR THIS RANGE

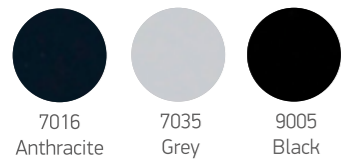

- » Non-standard colors are available with price difference (extra charge)
- » Production codes are referring items completely in color Grey 7035

DOOR OPENING DEGREE

Max 195°

SHELF CLIP & INCREMENT

36

INTUMESCENT STRIP

LOCKING DETAIL

4 Direction
(7 Points) Locking

4 Direction
(8 Points) Locking

4 Direction
(11 Points) Locking

CLOSING DIRECTIONS

- Monoblock
- Powder Coated
- Key Lock
- Suspension File
- Cleaning
- WARRANTY**
2 YEARS
WARRANTY
Warranty



view						
catalogue code	FSC.8070	FSC.1270	FSC.1570	FSC.1970	FSC.1995	FSC.1912
production code	152M1101-00001	152M1101-00002	152M1101-00003	152M1101-00004	152M1101-00005	152M1101-00006
no of door	1 right hand	1 right hand	1 right hand	1 right hand	2 swing	2 swing
no of shelf	1	2	3	4	4	4
height (mm)	800	1200	1500	1950	1950	1950
width (mm)	700	700	700	700	950	1200
depth (mm)	550	550	550	550	550	550

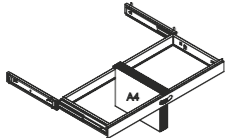
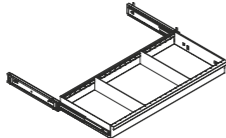
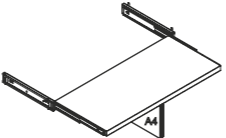

ROLL-OUT ACCESSORIES

view						
catalogue code	TLF/FSC.9555	TLF/FSC.1255	TLD/FSC.9555	TLD/FSC.1255	TLS/FSC.9555	TLS/FSC.1255
production code	152M9907-00001	152M9907-00002	152M9907-00003	152M9907-00004	152M9907-00005	152M9907-00006
item	telescopic frame		telescopic drawer		telescopic shelf	
suspension file size	LETTER+A4+FOLIO+FS	LETTER+A4+FOLIO+FS	N/A	N/A	A4	A4
for cabinets	950(w)*550(d)	1200(w)*550(d)	950(w)*550(d)	1200(w)*550(d)	950(w)*550(d)	1200(w)*550(d)

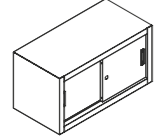
view	
catalogue code	SLIC/FSC.9555
production code	152M9907-00007
item	inner cupboard
height (mm)	420
width (mm)	800
depth (mm)	400



AS

- » Durable Welded Metal Construction
- » Electrostatic Powder Coating
- » High Quality Safe Lock with Single Direction Locking with 2 Keys
- » No Key Duplicate & No Masterkey Support
- » Packaging: Nylon Bag + Corrugated Carton

STANDARD COLORS FOR THIS RANGE



- » Non-standard colors are available with price difference (extra charge)
- » Production codes are referring items completely in color Grey 7035

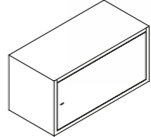

view	
catalogue code	SFB.408038
production code	152M1102-00001
height (mm)	400
width (mm)	800
depth (mm)	380



Monoblock

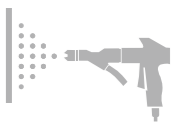

Powder Coated



Key Lock



Cleaning



Warranty

OTHERS

AS

- » Durable Welded Metal Construction
- » Electrostatic Powder Coating
- » Wall Mounting Holes on Rear Top
- » 1 Full Size Upper Shelf
- » Adjustable Small Shelves on Right or Left
- » Coat Rail with Hook on Right or Left
- » Reinforced Doors with Concealed Hinges and Anti-Noise Plastic Buffers
- » 2.000 Differs 2 Point Flush Handle Lock with 2 Keys
- » Key Duplicate Support
- » Masterkey Support
- » Packaging: Nylon Bag + Corrugated Carton
- » Effective Transport for Sets with Two Cupboards in One Package

- » 1.000 Differs 3 Point Flush Handle Lock with 2 Keys
- » Flatpack Model

STANDARD COLORS FOR THIS RANGE

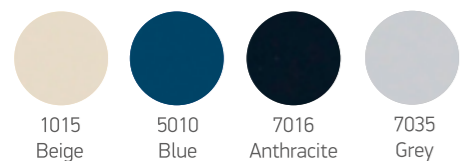

- » Non-standard colors are available with price difference (extra charge)
- » Production codes are referring items completely in color Grey 7035

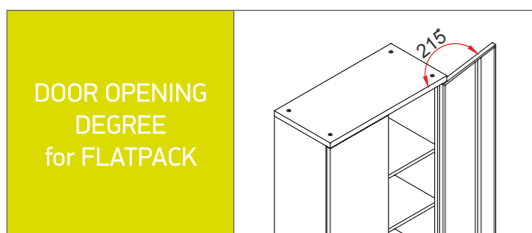
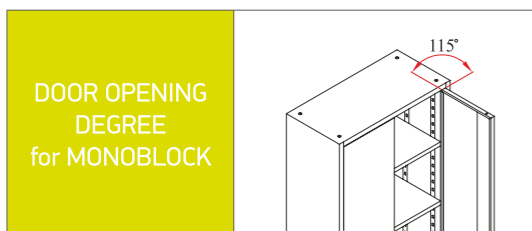

- Monoblock
- Powder Coated
- Key Lock
- Cleaning
- 2 YEARS WARRANTY** Warranty



view								
catalogue code	UNC.18	UNC.18D50	UNC.19	UNC/HD.19	UNC/FP.19	UNC/4S.1959242	UNC/4S.1959250	UNC/4S.1959260
production code	152M0802-00009	152M0802-00010	152M0802-00011	152M0802-00012	152M0802-00013	152M0802-00014	152M0802-00015	152M0802-00016
construction	welded	welded	welded	welded	flatpack	welded	welded	welded
no of doors	2 swing	2 swing	2 swing	2 swing	2 swing	2 swing	2 swing	2 swing
divider	T-Shelf	T-Shelf	T-Shelf	T-Shelf	T-Shelf	T-Shelf	T-Shelf	T-Shelf
no of shelves	1 full + 3 half	1 full + 3 half	1 full + 3 half	1 full + 3 half	1 full + 3 half	1 full + 4 half	1 full + 4 half	1 full + 4 half
height (mm)	1800	1800	1950	1950	1950	1950	1950	1950
width (mm)	800	800	925	925	916	925	925	925
depth (mm)	383	500	422	422	422	422	500	600

AS

- » Durable Metal Construction
- » Electrostatic Powder Coating
- » Reinforced Doors with Semi-Concealed Hinges and Anti-Noise Plastic Buffers
- » Stamped Label Holder on Doors
- » Round Perforated Doors for Air Circulation
- » Fixed Hooks on Doors
- » Saddle Storage up to 3 pcs in Big Model
- » Adjustable Shelves & Side Hooks
- » 2.000 Differs Round Head Camlock with 2 Keys
- » Key Duplicate Support
- » Masterkey Support
- » Packaging: Nylon Bag + Corrugated Carton

STANDARD COLORS FOR THIS RANGE



7035
Grey

- » Non-standard colors are available with price difference (extra charge)
- » Production codes are referring items completely in color Grey 7035



Monoblock



Powder Coated



Key Lock



Aeration



Cleaning



Warranty

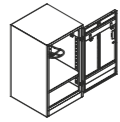
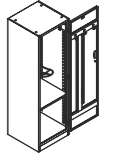

view		
catalogue code	SSC.13	SSC.19
production code	152M9704-00001	152M9704-00002
no of rack	1	1
no of shelf	1	1
no of side hook	1	2
height (mm)	1030	1950
width (mm)	600	600
depth (mm)	600	600

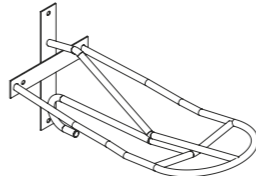
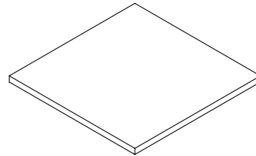
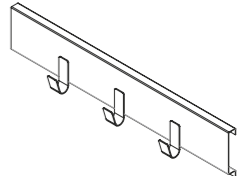
view			
catalogue code	SR/SSC.60	SF/SSC.60	SH/SSC.60
production code	152M9908-00001	152M9908-00002	152M9908-00003
item	rack	shelf	side hook

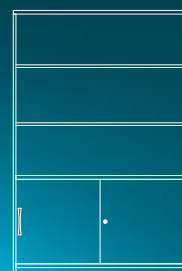
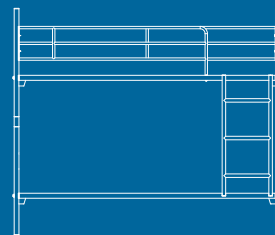
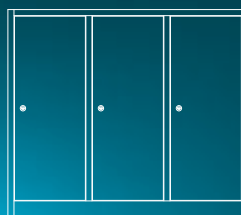
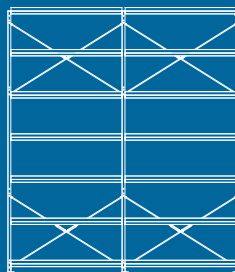
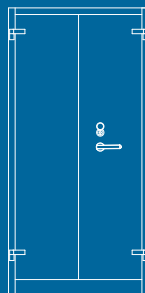
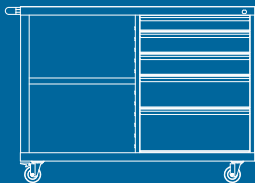
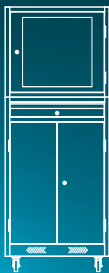

**MB**HANDEL

MB Handel GmbH

Raiffeisenstr. 13

D-71126 Gäufelden

Tel +49 (0)7032 / 91 04 36-0

Fax +49 (0)7032 / 91 04 36-4

E-Mail info@mb-handel-gmbh.de

Web www.mb-handel-gmbh.de